



Offal batching reduces seabird attendance at fishing vessels

Edward Abraham, Yvan Richard, Finlay Thompson

edward@dragonfly.co.nz



Department of Conservation
11 April 2011

Offal is the key

- Seabirds are attracted to trawlers by discards, processing waste, and by the catch
- While feeding, they may be struck by trawl warps and killed
- Warp strike observations show that few strikes occur if there is no waste discharge

Mealing, mincing, batching

- Previous studies have shown that when a meal plant is used, and so all processing waste is retained, then there are fewer birds attracted to the stern of vessels
- One approach to reducing interactions include mincing offal so that it disperses further than the stern
- Another approach is to batch the offal and discard it at intervals
- A previous study found that as the batch interval increased from thirty minutes to four and eight hours, there was some decrease in the numbers of birds that were attracted to the discharge events

The 2010 experiment

- In 2010, the batching experiment was repeated on a trawler fishing for hoki and beryx species
- The number of birds behind the vessel were compared between continuous discharge, and discharge at 30 min and 2 hour intervals
- In this report, a preliminary analysis of the results is presented

The Mitigation TAG

- The experiments coordinated by the Mitigation Technical Advisory Group
- Collaboration between DOC, MFish, NGO's, SeaFIC, fishing industry, and research providers
- 2010 batching experiment carried out by a fisheries observer with support from vessel crew
- Vessel operations coordinated by John Cleal (Vessel Management Services Ltd)
- Project and preliminary analysis funded by DOC CSP
- Further analysis funded by ACAP

Discharge and seabird abundance

- The number of birds behind the vessel are counted
- Counts made during both fishing and processing
- Normal fishing carried out
- Discharge either continuous, 30-min batches, or 2-hour batches

An observation

- Counts made of
 - Large birds (Albatrosses and giant petrels)
 - Cape petrel (*Daption spp.*)
 - Small birds (other birds)
- Counts made with 10 m and 40 m sweeps
- Counts made of birds in air and on water
- Up to 12 counts in a session

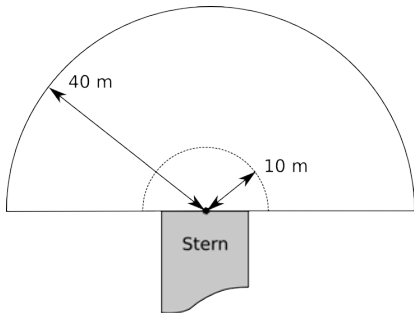

Seabird observation form (Controlled batch vs 'continuous')

Date observations started (ddmmyy) | 18 | 02 | 10

Sample identification

Trip number	Tow number	Batching 2010 Number 38	Experimental regime		
		www.dmp.govt.nz	30 min batch	2 hr batch	Continuous discharge

Background information (record before first observation)

Vessel speed (knots)	4.1	End time of previous discharge (i.e. end of previous batch or stream of 'continuous' discharge)	1103
Swoll height (metres)	2m	Previous batch volume (kg)	300

Observation		1	2	3	4	5	6	7	8	9	10	11	12	
Time	Hour	11	11	11	11	11	11	11	11	11	11	11	11	
	Minute	20	25	30	35	40	45	50	55	00	05	10	15	
Wind strength (Beaufort)		5	5	5	5	5	5	5	5	5	5	5	5	
Tow stage (S, F, H)		F	F	F	F	F	F	F	F	F	F	F	F	
# vessels visible		0	0	0	0	0	0	0	0	0	0	0	0	
Discharge	Sump	3	3	3	3	3	3	3	3	3	3	3	3	
	Mixed	0	0	0	0	0	0	0	0	0	0	0	0	
	Offal	0	0	3	0	0	0	0	0	3	0	0	0	
	Whole discards	0	0	1	0	0	0	0	0	0	0	0	0	
Large birds	40m	Air	50	60	100	80	50	50	40	60	70	80	30	40
	10m	Air	5	0	10	5	3	2	0	1	20	20	2	5
Sey birds	40m	Air	60	40	50	30	20	40	30	20	40	20	50	60
	10m	Air	10	0	10	5	3	4	2	0	5	0	2	0
Cape pigeon	40m	Air	1	0	0	0	0	0	0	0	0	0	0	0
	10m	Air	0	0	0	0	0	0	0	0	0	0	0	0

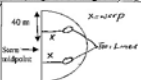
Comments
Diagram of tori lines and sampling area during sampling

Batch characteristics (batching treatments only)

Batch start time	1130
Batch finish time	1132
Batch volume (kg)	200
Main type (S, F, C)	F

Small birds are not counted by the 10-20 birds during discharge - used hauled immediately after sampling.



Seabird species

Type	Species	Code	Abundance	
			mean	min-max
Large	Unidentified small albatross	XMA	38.6	10-100
	Salvin's albatross	XSA	38.4	5-80
	Giant petrel	XTP	25.8	10-90
	White-capped albatross	XWM	24.1	0-80
	Buller's albatross	XBM	18.4	0-60
	Unidentified large albatross	XAL	14.2	5-40
Small	Westland petrel	XWP	39.3	10-80
	Unidentified petrel	XPE	27.9	0-80
	Grey petrel	XGP	12.3	0-40
Cape petrel	Cape petrel	XCP	4.1	0-30



Total counts

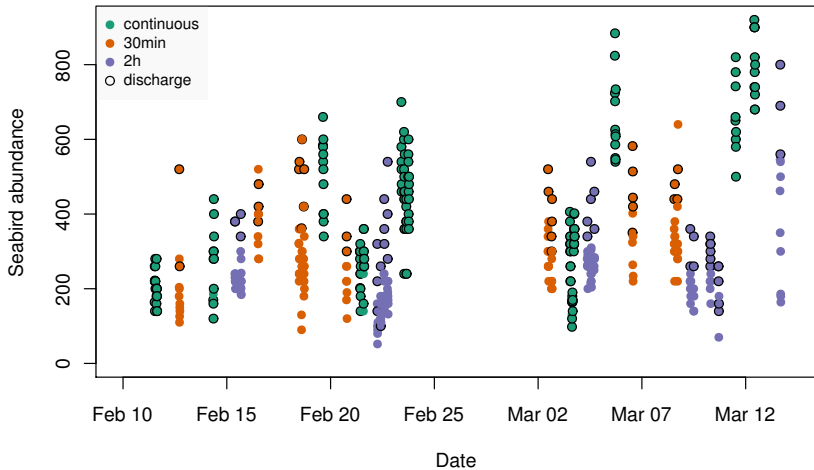



Effect of discharge

- Difference between treatments due to the greater time spent discharging in the continuous treatment
- Proportion of observations with discharge: 97% continuous, 22% (30-min), and 25% (2-hour)
- Typical duration of a session was 40 min (a maximum of 55 min)

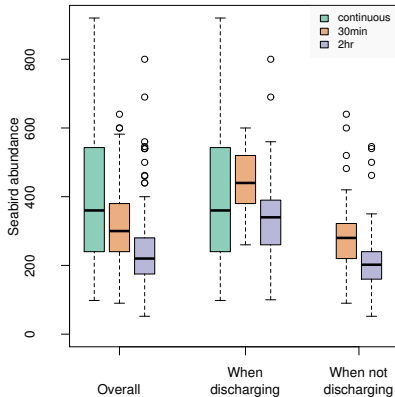



Effect of discharge

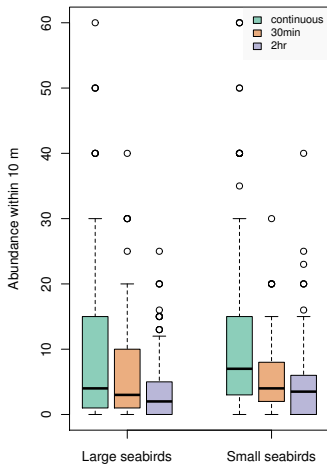
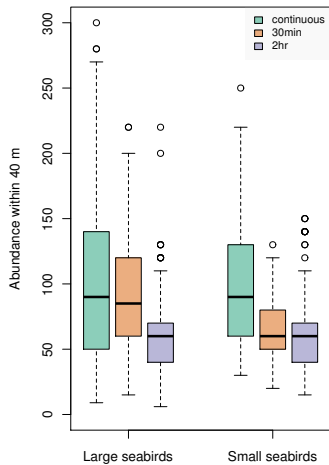

Time response (total birds, 40 m)

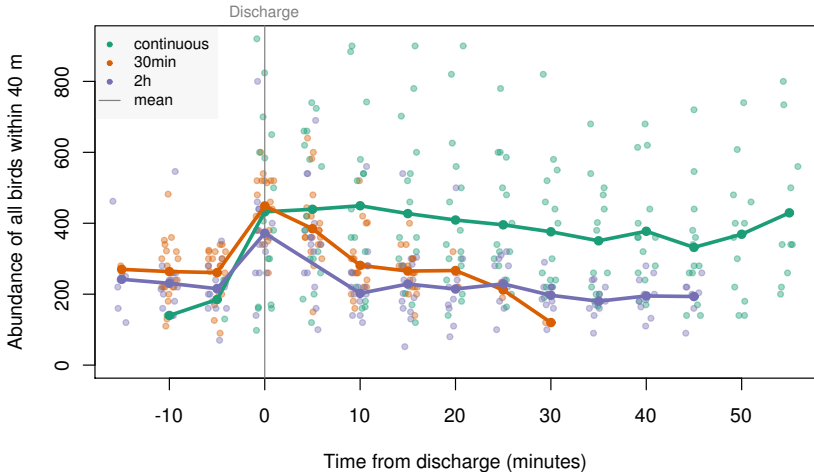

Time response (total birds, 10 m)

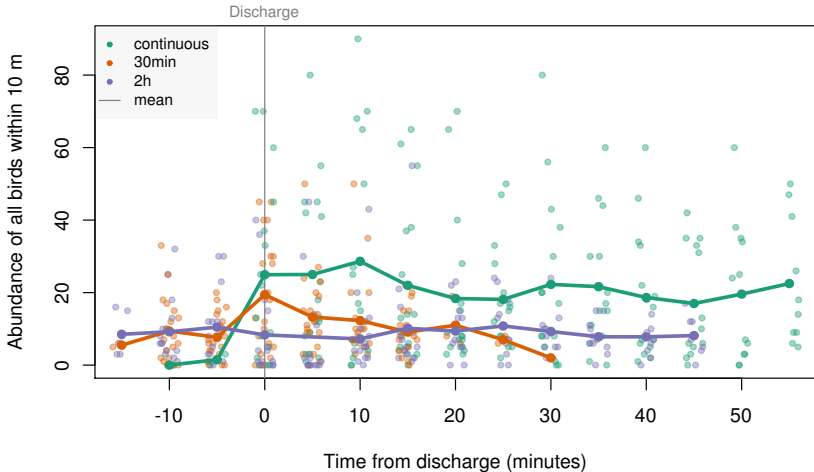

Discharge duration

- Average duration of discharge was 3.1 min for the 30-min treatment, and 9.4-min for the 2 hour treatment
- Relative effect of 2-hour and 30-min treatment would depend on the speed of the response of birds to the discharge event
- Unable to determine this from the 5-min count protocol

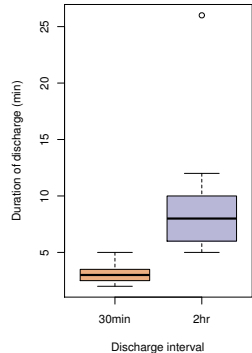



Summary

- Continuous discharge maintains a high number of birds close to the vessel
- Bird numbers increase and decrease rapidly in response to discharge events
- This results in fewer birds behind the vessel during batched treatment
- Will quantify the difference using statistical analysis of the data