

# McCulloughs Creek Hydropower Project

Whataroa, Westland, New Zealand



## ENVIRONMENTAL IMPACT ASSESSMENT

In Support of No.8 Limited - DOC Concession Application

Friday, 20 October 2017

## Executive Summary

This Environmental Impact Statement (EIA) outlines the proposed McCulloughs Creek Hydropower Development, describes the existing natural environment and identifies the potential effects that the activity will have. This EIA supports the application by No.8 Limited for a DOC Concession Application.

The proposed *Activity* is the installation and operation of a 1,890 kW run-of-river hydropower scheme. The intake of the scheme would be located on the upper reach of McCulloughs Creek at approximate elevation 520 metres above sea level (masl). A HDPE and GRP/steel penstock would convey the water to a powerhouse located at elevation 120 masl. The water would flow back into McCulloughs Creek at this point and discharge naturally to the Whataroa, another 1.5 km downstream.

The overall philosophy is to use as little water as possible, avoid important fish habitat, reduce effects to the terrestrial values by limiting the required corridor for structures and access where possible, and provide access for the public.

In order to construct the scheme, No. 8 is proposing to use a cableway and helicopters for construction. This construction method is low impact and once construction is completed, the cableway will be removed and the bush allowed to regenerate in areas not used by the scheme.

The benefits of the project to DOC, the public and the general West Coast economy are:

- *Employment of local contractors and ongoing, long term roles for operation and maintenance personnel,*
- *Strengthening of the Westpower network as a result of feeding generation into the distribution grid near Whataroa substation,*
- *The installation of a publically accessible track, information and an elevated lookout to experience the scenic reserve and the views across the Whataroa plains,*
- *the base-lining, ongoing monitoring and protection of indigenous flora and fauna in the area,*
- *hydrological and climate data recording, in conjunction with other observations made from having the scheme in operation will be of benefit to science in general, and*
- *ecologists, seismologists and other specialists would be able to easily observe and study the natural ecosystem and landscape due to improved access.*

# Table of Contents

Executive Summary.....	i
Table of Contents.....	ii
List of Tables.....	iv
List of Figures.....	iv
Acronyms and Abbreviations .....	vi
<b>1 The Applicant and project drivers.....</b>	<b>1</b>
<b>1.1 Principles for developing a low impact hydropower scheme .....</b>	<b>1</b>
1.1.1 <i>Low flows and high head .....</i>	<i>1</i>
1.1.2 <i>Low impact run-of-river intakes.....</i>	<i>2</i>
1.1.3 <i>Avoiding fish and aquatic life.....</i>	<i>3</i>
1.1.4 <i>Avoiding removal of large areas of native bush .....</i>	<i>3</i>
1.1.5 <i>Improved access for public.....</i>	<i>3</i>
<b>2 The Activity – McCulloughs Creek Hydropower Project.....</b>	<b>5</b>
<b>2.1 McCulloughs Creek Hydropower Project concept.....</b>	<b>5</b>
2.1.1 <i>Options, alternative locations and siting of project structures .....</i>	<i>6</i>
<b>2.2 Description of Project Components.....</b>	<b>8</b>
2.2.1 <i>Intake .....</i>	<i>8</i>
2.2.2 <i>Desander.....</i>	<i>12</i>
2.2.3 <i>Penstock.....</i>	<i>13</i>
2.2.4 <i>Turbine and Generator.....</i>	<i>15</i>
2.2.5 <i>Powerhouse and tailrace .....</i>	<i>15</i>
<b>2.3 Access.....</b>	<b>17</b>
2.3.1 <i>Temporary construction access .....</i>	<i>17</i>
2.3.2 <i>Access to Highway 6.....</i>	<i>18</i>
2.3.3 <i>Cableways used for construction.....</i>	<i>19</i>
2.3.4 <i>Permanent access .....</i>	<i>20</i>
<b>2.4 Scheme footprint and required clearing.....</b>	<b>21</b>
2.4.1 <i>Construction sequence and methodology.....</i>	<i>22</i>
2.4.2 <i>Interconnection to Westpower Network.....</i>	<i>23</i>
<b>2.5 Desired Corridor for DOC Licence.....</b>	<b>24</b>
<b>2.6 Potential for improvements to access and scenic values .....</b>	<b>25</b>
<b>2.7 Property ownership .....</b>	<b>27</b>
<b>2.8 Employment.....</b>	<b>28</b>
<b>3 The Natural Environment .....</b>	<b>29</b>
<b>3.1 Hydrology.....</b>	<b>30</b>
3.1.1 <i>Rainfall .....</i>	<i>31</i>
3.1.2 <i>Installation of flow gauging .....</i>	<i>34</i>
3.1.3 <i>Hydrometric gauging and flow proration .....</i>	<i>35</i>
3.1.4 <i>Average flow and flow series data .....</i>	<i>37</i>
3.1.5 <i>Low flows .....</i>	<i>39</i>
3.1.6 <i>Floods.....</i>	<i>41</i>
3.1.7 <i>Hydrological Summary.....</i>	<i>41</i>
<b>3.2 Geology.....</b>	<b>42</b>
<b>3.3 Ecology .....</b>	<b>42</b>
3.3.1 <i>Flora .....</i>	<i>42</i>

3.3.2	<i>Observed and reported flora</i> .....	43
3.3.3	<i>Fauna</i> .....	43
3.3.4	<i>Observed and reported fauna</i> .....	44
3.3.5	<i>Freshwater fish and macroinvertebrates</i> .....	44
3.4	<b>Archaeological &amp; Historic Sites</b> .....	45
3.5	<b>Existing Social Environment</b> .....	45
<b>4</b>	<b>Effects of the Activity</b> .....	<b>46</b>
4.1	<b>Effects on freshwater ecosystem and mitigation measures</b> .....	<b>47</b>
4.2	<b>Effects on vegetation</b> .....	<b>55</b>
4.3	<b>Summary of Mitigation measures for freshwater ecology and vegetation</b> .....	<b>59</b>
4.4	<b>Effects on terrestrial and landscape values</b> .....	<b>60</b>
4.4.1	<i>Waste and contamination</i> .....	60
4.5	<b>Recreation, enjoyment and free access</b> .....	<b>61</b>
4.5.1	<i>Noise</i> .....	61
4.5.2	<i>Public Safety</i> .....	61
4.5.3	<i>Mitigation measures</i> .....	61
4.6	<b>Visual effects</b> .....	<b>62</b>
4.6.1	<i>Viewshed Analysis</i> .....	63
4.6.2	<i>Access tracks in native West Coast rainforest for comparison</i> .....	64
4.6.3	<i>Mitigation measures to mitigate visual impacts</i> .....	67
4.7	<b>Effects on Historic values</b> .....	<b>67</b>
4.7.1	<i>Mitigation measures</i> .....	68
4.8	<b>Effects on Cultural values</b> .....	<b>68</b>
4.8.1	<i>Mitigation measures</i> .....	68
4.9	<b>Infrastructure Effects</b> .....	<b>68</b>
4.9.1	<i>Mitigation measures</i> .....	68
4.10	<b>Cumulative Effects</b> .....	<b>68</b>
<b>5</b>	<b>Statutory Provisions</b> .....	<b>69</b>
5.1	<b>Concession Applications and the Conservation Act 1987</b> .....	<b>69</b>
5.2	<b>Provisions of the Act and the purpose for which the land is held</b> .....	<b>71</b>
5.2.1	<i>Conservation Act 1987</i> .....	71
5.2.2	<i>The Department of Conservation</i> .....	72
5.2.3	<i>Purpose for which the land is held</i> .....	72
5.2.4	<i>Conservation General Policy 2005</i> .....	76
5.2.5	<i>West Coast Conservation Management Strategy 2010-2020</i> .....	78
5.2.6	<i>Location on conservation land</i> .....	86
5.2.7	<i>Granting of lease or licence</i> .....	87
5.3	<b>Term and expiry date</b> .....	<b>88</b>
5.4	<b>Conclusion</b> .....	<b>89</b>

**APPENDIX A – McCulloughs Creek Hydropower Project and Project Application Corridor**

**APPENDIX B – Wildlands Ecological Assessment Report**

## List of Tables

Table 1 – McCulloughs Creek Hydropower Project Salient Features.....	5
Table 2 - Salient features of turbine and generator .....	15
Table 3 – Areas of land permanently cleared (after regeneration) for proposed scheme .....	22
Table 4 - McCulloughs Creek catchments and Poerua at Lower Gorge gauge site .....	35
Table 5 – Actual flow measurements on McCulloughs Creek and Poerua Gauge site.....	36
Table 6 – Final Proration Factor .....	37
Table 7 – Methods to estimate MALF .....	41
Table 8 – Flood magnitude and return period.....	41
Table 9 – Hydrology at intake site .....	42
Table 10 - Identified construction effects on the freshwater ecosystem and mitigation measures .....	51
Table 11 - Identified operational effects on the freshwater ecosystem and mitigation measures .....	52
Table 12 - Identified construction effects on vegetation and mitigation measures .....	57
Table 13 - Identified operational effects on vegetation and mitigation measures.....	58

## List of Figures

Figure 1 - Example of a Coanda weir .....	2
Figure 2 - Example of typical access track in native bush .....	4
Figure 3 – Coanda screen with grizzly bars.....	10
Figure 4 – Indicative dimensions of proposed Coanda intake and weir .....	10
Figure 5 – Example of a Coanda style intake .....	11
Figure 6 – Indicative plan of proposed weir and dewatering sequence .....	12
Figure 7 – Desander .....	13
Figure 8 - Example of HDPE penstock alignment.....	14
Figure 9 - Turbine and generator dimensions .....	15
Figure 10 – Approximate dimension and style of powerhouse .....	16
Figure 11 – Example of Pelton turbine powerhouse and tailrace above river water level .....	16
Figure 12 – Example of cableway used for penstock construction.....	18
Figure 13 – Access from highway .....	19
Figure 14 – Intermediate support example .....	20
Figure 15 – Dimensions of penstock access track .....	20
Figure 16 - 11 kV Westpower distribution line .....	24
Figure 17 –View from near the proposed lookout location.....	26
Figure 18 –View from near the proposed lookout location.....	26
Figure 19 –View from penstock route on Wye Creek Scheme (Pioneer Generation) in Central Otago	27
Figure 20 –Property Ownership near McCulloughs Creek.....	27
Figure 21 – Whataroa Farmland near the McCulloughs Creek crossing.....	29
Figure 22 – Left: View upstream in flat farmland reach of the river (EL 100 m). Right: View upstream in the steeper sub-alpine reaches of the creek (EL 200 m). .....	31

Figure 23 – View looking downstream from the proposed intake site.....	32
Figure 24 – Mean Annual Rainfall at Gauges near McCulloughs Creek Intake .....	33
Figure 25 – Map showing NIWA rain gauges, hydrometric gauges and rainfall isohyets .....	33
Figure 26 – Gauge site location .....	34
Figure 27 – McCulloughs Creek Control Cross Section.....	34
Figure 28 – Map showing McCulloughs Creek Hydropower Scheme and catchment at the intake site	36
Figure 29 –Flow at McCulloughs Creek intake (prorated from Poerua at Lower Gorge).....	38
Figure 30 – Estimated flow duration curve at McCulloughs Creek intake .....	38
Figure 31 –MALF Specific Yield Map – NIWA.....	40
Figure 32 – View from south side of McCulloughs Creek Bridge on Highway 6 showing view obscured by forest cover. ....	63
Figure 33 – Viewshed Analysis.....	64
Figure 34 - Lake Wombat Track.....	65
Figure 35 - Lake Wombat Track showing the track obscured by native forest canopy - Franz Josef.....	65
Figure 36 - Callery Gorge Walk showing the track obscured by native forest canopy - Franz Josef ....	66
Figure 37 – Callery Gorge Walk showing the track obscured by native forest canopy - Franz Josef ...	66

## Acronyms and Abbreviations

EIA	Environmental Impact Assessment
HDPE	High density polyethylene (pipe)
GRP	Glass reinforced plastic (pipe)
DOC	Department of Conservation
CMS	Conservation management strategy
NIWA	National Institute of Water and Atmospheric Research
LINZ	Land Institute of New Zealand
EL	Elevation (above sea level)
GIS	Geographic information system
MALF	Mean annual low flow
MAF	Mean annual flow
NZTA	New Zealand Transport Agency
SCADA	Supervisory control and data acquisition (control systems)
SH 6	State Highway 6
REC	River Environment Classification

# 1 The Applicant and project drivers

No 8 Limited aims to develop low-impact mini hydropower schemes in New Zealand. The schemes currently being considered are geographically diverse and are in the range of 500 kW to 2,000 kW. The company directors are Fergus Cleaver, chartered accountant and Jeremy Kent-Johnston, chartered professional hydropower engineer and project manager.

The purpose of this document is to describe the activity and effects of the activity being proposed. The proposed project is a 1,890 kW scheme on McCulloughs Creek on the West Coast of the South Island. The scheme would be located on conservation land administered by the Department of Conservation (DOC). The following section, Section 1.1, outlines the underlying philosophy of No. 8 Limited, which is the development of small, low impact, run-of-river hydropower schemes. The definition of low impact is subjective so the following section aims to define this goal.

## 1.1 Principles for developing a low impact hydropower scheme

This section outlines the factors that are required to develop a low impact hydropower scheme. The overall philosophy is to use as little water as possible, avoid important fish habitat, reduce effects to the terrestrial values by limiting the required corridor for structures and access where possible, and provide access for the public. Low impact hydropower is possible, but requires careful site selection to ensure that these principles can be met, while still achieving a viable project. It also requires good knowledge of hydropower technology and understanding of the drivers of successful projects to be able to minimise effects that plague traditional hydropower schemes.

### 1.1.1 Low flows and high head

In order to design a low impact hydropower scheme, a number of fundamental aspects regarding hydropower technology must be considered. The power generated by a hydropower project is a function of the flow through the turbine (discharge) and the vertical height from the turbine to the intake (head). The equation relating these variables to the output is as follows:

$$P = \rho \cdot g \cdot Q \cdot h \cdot \mu$$

Where:  $P$  = power output (W),  $\rho$  = density of water (1000 kg/m<sup>3</sup>),  $g$  = the gravitational constant (9.81 m/s<sup>2</sup>),  $Q$  = discharge (m<sup>3</sup>/s) and  $h$  = head (m), and  $\mu$  = efficiency.

From this equation, it can be seen that power can be increased by increasing the discharge,  $Q$  or increasing the head,  $h$  (with the other variables constant). Generally, water for hydropower schemes is taken from a river environment, so from an effect-based point-of-view, it is desirable to take the minimum possible volume of water from the stream. Therefore, to develop a low impact hydropower scheme, the focus needs to be maximizing the head,  $h$ .

The scheme being proposed by No. 8 Limited aims to use as little water and as much head as possible to generate power. This is to ensure that the natural state of the river is modified as little as possible.



### 1.1.2 Low impact run-of-river intakes

Traditionally, the two methods for delivering water to the hydropower turbine are via a dam or river intake. The purpose of the intake is to separate the water from the river and remove any debris and sediment in the flow.

In order to develop a low impact hydropower scheme, changing the river flows significantly by using a dam or large weir is avoided. The scheme proposed in this application is referred to as *run-of-river*, which means that the river is not dammed and the water taken is returned to the stream a short distance downstream after passing through the turbine.

No. 8 Limited proposes using a Coanda screen intake, which is an intake utilising the Coanda effect<sup>1</sup> to extract water. Coanda screens are tilted profile wire bar screens and the shape of the screen allows the screen to remain clean with little or no mechanical cleaning. A portion of the water is removed through the steel grill (and taken to the turbine) and the balance of the water continues downstream. The intake design also allows for:

- fish passage,
- sediment and debris to be passed downstream, and
- unimpeded flow over the weir.

Figure 1 provides an example of a Coanda intake for a scheme taking approximately two times the design flow rate of the McCullough's Creek Project (1,100 l/s).



Figure 1 - Example of a Coanda weir

---

<sup>1</sup> [https://en.wikipedia.org/wiki/Coand%C4%83\\_effect](https://en.wikipedia.org/wiki/Coand%C4%83_effect)

### 1.1.3 Avoiding fish and aquatic life

Another advantage of seeking projects with high head is that they are often located in areas with high elevation, steep topography and are drained by a river with large drops and waterfalls. This means that in many of these locations, abundance of fish and aquatic life is less than compared to streams at lower elevation.

Avoiding impact to native New Zealand fish, including eels, galaxiids, trout and salmon, is of utmost importance to No.8 Limited. The avoidance impact to fish is one of the primary criteria in the selection of sites for potential projects.

### 1.1.4 Avoiding removal of large areas of native bush

When a hydropower scheme is constructed, a road from the powerhouse to the intake is generally required. This road initially provides access for construction vehicles such as excavators and bulldozers required to construct the intake, penstock and powerhouse. After construction, these roads allow access to the scheme components for the operation and maintenance of the scheme.

However, installing vehicular access requires removal of large areas of bush to form the road. Due to vehicle limitations, the road cannot exceed a maximum grade of 14 – 20%. For a scheme with high head, this can result in a 2.0 – 5.0 km road, switching back through the bush, as it is required to climb to the elevation of the intake. This road construction can result in the permanent removal of large areas of bush, in addition to having a significant effect to the visual qualities of the area.

In order to develop a low-impact scheme, No.8 Limited would utilise:

1. a temporary aerial cableway and helicopter to construct the scheme, and
2. a foot access track for permanent access. This track would be able to be made much steeper than a vehicle road, much shorter and with significantly less impact.

This methodology would allow the construction of scheme components without constructing roads for vehicular traffic.

The cableway will be constructed directly above the penstock alignment to allow the transport of materials and pipe to where they need to be installed. The cableway will be installed through the vegetation without removal of the canopy trees larger than 30 cm dbh. (diameter at breast height). Once the construction of the penstock, intake and desander is complete, the cableway would be removed and low level bush allowed to regenerate in areas not used by the scheme.

Once operational, the pedestrian access track would be around 1.0 to 0.75 m wide, next to the pipeline allowing the passage of foot traffic while allowing the avoidance of large vegetation and natural features. The track would serve as access for the construction staff and allow operation and maintenance of the intake and penstock on foot.

### 1.1.5 Improved access for public

No.8 Limited proposes to improve access to the general area by the construction of the *penstock access track* and the *lookout* at the summit. No.8 proposes to provide public access to the lookout

point so that the public can visit the Whataroa Scenic Reserve and see spectacular views across the Whataroa plains.

The improved access would assist DOC in carrying out activities including pest control for possums and goats. This aspect is discussed in detail in Section 2.5 - Potential for improvements to access and scenic values. Figure 2 provides an example of a similar track to that described, in native New Zealand bush. According to DOC definitions<sup>2</sup>, the track would be in the “route” category, with natural, rough, muddy or very steep parts and unbridged stream and river crossings.



*Figure 2 - Example of typical access track in native bush*

The access track and walk would feature a steep climb approximately 400 m in elevation with views to the west, across the Whataroa farmland. There would be a further 1.7 km of track traversing the valley to the proposed intake location. The proposed track is inspired by Pioneer Generation’s Wye Creek<sup>3</sup> hydropower scheme, where there is a public access track, alongside the penstock, so that the public, hunters and DOC can gain access to the area.

---

<sup>2</sup> <http://www.doc.govt.nz/parks-and-recreation/things-to-do/walking-and-tramping/track-categories/>

<sup>3</sup> <http://www.doc.govt.nz/parks-and-recreation/places-to-go/otago/places/remarkables-conservation-area/things-to-do/lower-wye-creek-track/>

## 2 The Activity – McCulloughs Creek Hydropower Project

This section describes the technical features of the McCulloughs Creek Hydropower Project and rationale for selection of locations and project structures. A number of site investigations and studies need to take place before settling on the final detailed design layout. The design of the scheme is currently based upon:

1. Publically available information provided by agencies such as DOC, NIWA, LINZ and Landcare Research,
2. Site specific information derived from site visits, and
3. Information derived from engineering analyses, such as hydrology and topographical calculations.

The entire scheme would be located on DOC Conservation Land, specifically, the Waitangi Forest Conservation Area and the Whataroa Scenic Reserve. Land ownership is discussed in Section 2.6. No.8 Limited proposes to use a corridor approach in the DOC concession application because it allows a low impact approach to the design where natural features, flora and fauna can be avoided.

### 2.1 McCulloughs Creek Hydropower Project concept

The activity is the installation and operation of a 1,890 kW hydropower scheme. The intake would be located on McCulloughs Creek, a tributary of the Whataroa River, at approximate elevation EL 520 metres above sea level (masl). The proposed powerhouse is to be located at elevation 120 masl on the same creek approximately 3.0 km downstream.

The following sections describe the components of the scheme in further detail. Appendix A shows an indicative site plan for the proposed scheme, with the project components identified. This indicative site plan also shows the corridor which No.8 Limited is applying for, through a DOC concession. Table 1 outlines the salient features of the McCulloughs Creek Hydropower Project.

*Table 1 – McCulloughs Creek Hydropower Project Salient Features*

Description	Detail
<b>Name</b>	McCulloughs Creek Hydropower Project
<b>Rated Output</b>	1,890 kW
<b>Rated Flow</b>	600 l/s
<b>Headwater Level</b>	520 masl
<b>Normal tailwater level</b>	120 masl
<b>HDPE</b>	625 mm Ø
<b>GRP/Steel penstocks</b>	550 mm Ø
<b>Gross head</b>	400 m
<b>Net head (Hn)</b>	377 m
<b>Turbine</b>	Horizontal Pelton, 2 jet, 750 rpm
<b>Distribution line length</b>	~700 m

### 2.1.1 Options, alternative locations and siting of project structures

This section outlines the rationale for selecting the site and locations of the scheme components. The selection of the site itself is a result of assessment of ten sites in the South Island. This assessment included a site visit and engineering assessment, discussions with Westpower to determine the viability of exporting electricity and an economic assessment to determine financial viability.

The location of each component was dependent on a number of factors, related to engineering, topographical and hydrological constraints. Generally, for a given site there are limited ways the scheme can be arranged. The following sections describe the constraints and reasons for choosing the final locations of the powerhouse, intake, penstock and access. In addition, the selection of the design flow is discussed.

#### 2.1.1.1 Selection of site location.

A number of sites were investigated before the selection of the McCulloughs Creek site. The initial list of prospective sites was determined by running a proprietary GIS (geographical information system) tool to determine areas of hydropower potential. In addition, the software identified locations where the low impact hydropower approach could be utilised. The general methodology for identification of sites was to:

- 1) determine the average flows (hydrology) in the rivers in the areas of interest, then
- 2) determine the hydropower potential in the area using the hydrological data, and then
- 3) estimate a cost for each scheme in order to rank and isolate the best schemes for further development.

The majority of the sites assessed were not viable. The reasons varied for each location, but in general, most sites were discounted because:

- the distances to the electrical load or sub-station presented limitations that meant there would be difficulties with exporting power to the grid,
- there were sensitive ecosystems discovered in the area,
- there were private landowners who did not support the development, or
- there was inadequate hydrology for a small run-or-river project. For example, a flashy river system with low base flow and large floods.

With respect to the above issues, the McCulloughs Creek site was selected as the preferred location. The selected site is close to the Westpower distribution line and the Whataroa Substation, is on DOC Conservation Estate and has a good hydrological profile for a small hydropower development.

#### 2.1.1.2 Powerhouse location selection

This location of the powerhouse is based upon a number of factors. These factors include flood consideration, access, constructability and establishing sufficient head for an economic project.

At the McCulloughs Creek site, the selection of the proposed area for the powerhouse is based on the following:

1. The powerhouse need to be close to the river, to reduce the tailrace distance,
2. The powerhouse is located to ensure water is returned to the stream in the lower reaches for fish and ecological considerations. In this area brown trout, kōaro and torrentfish were observed so maintaining natural flows is important for these species,
3. The powerhouse area requires solid foundations, near to the river, but at a sufficient elevation to avoid flooding risk,
4. The powerhouse location is selected to ensure that the hydraulics in the penstock are acceptable. Moving the powerhouse further downstream would alter the ability of the turbine to operate appropriately, due to water hammer effects in the long penstocks. The current configuration ensures that the scheme is able to meet the requirements of the Grid Code and Westpower's network,
5. A critical factor for a hydropower scheme is the balance of maximising head (energy) and minimising the penstock distance (cost). The current powerhouse location provides sufficient head to justify project costs. If the powerhouse was located further downstream, the scheme would likely be non-viable, due to the significant expense of extra high pressure pipe.

#### ***2.1.1.3 Intake location selection***

The location of the intake has been selected using similar principals to that of the powerhouse. An ideal location for a run-of-river intake is where:

- the river channel has natural features which makes it possible to divert around the works during construction,
- the site has a solid, watertight foundation material for construction of civil works,
- there is an stable area on the banks to locate the desander and allow the flushing flows and sediment to flow back into the river,
- the area is away from any identifiable sensitive habitat and fish population, and
- the head is sufficient to allow energy to be produced while ensuring that the penstock is short enough to make the project viable.

The selected intake site on McCulloughs Creek satisfies the above criteria. At the selected intake site, the riverbed itself is exposed showing solid bedrock. This attribute means that the structure can be adequately bonded to the rock with anchors. A side flood channel allows bypass using sandbags during construction. Bypassing the water around the construction area is important to ensure that concrete and formwork can be constructed in the dry with limited risk of flood damage and contaminate discharge into the stream.

#### ***2.1.1.4 Access route selection***

Option 1 is the preferred route to construct the powerhouse and the alignment runs along the marginal strip from the State Highway to the powerhouse location. The two alignment options are shown in the site layout drawing in Appendix A. Option 2 may be used to establish the lower cableway support and laydown area.

The Option 1 alignment is preferred because:

- The physical area of the alignment corridor is less than Option 2, especially with respect to the Scenic Reserve lands, and hence, Option 1 will have less effect than the Option 2 access alignment.
- The Option 1 access grades are flat and therefore preferred. This is important because the access for the powerhouse is required to transport a number of heavy items such as the turbine, generator and transformers.

#### ***2.1.1.5 Selection of design flow***

The design flow was selected based on the available hydrology at the site. Hydrological calculations are outlined in Section 3.1 where the MALF was estimated at 250 l/s and the average flow estimated to be 1,100 l/s.

In order to determine the appropriate design flow, the energy output was estimated at a range of design flows (200 l/s to 600 l/s). This analysis took into consideration the minimum flow requirement for the turbine and stream. In addition, the analysis took into account the cost of the project and the potential revenue returned from the sale of energy to the grid.

From this analysis, it was determined that the design flow should be set at 600 l/s. A design flow in the range 200 l/s to 400 l/s appears to produce too little energy to recover the cost of the infrastructure, mostly due to the long penstock.

For the minimum flow requirements, a value of 80% of MALF was selected. This is consistent with Section 7.3.2 of the West Coast Regional and Water Plan. Based on the MALF calculation in Section 3.1.5 the MALF was assumed to be 250 l/s. Therefore the minimum flow for the intake site is assumed to be 200 l/s.

The flow duration curve for the site, showing the river, environmental and turbine flows is presented in Figure 30 in Section 3.1.

## **2.2 Description of Project Components**

This section describes each project component in detail. The sections are ordered from upstream (intake) to the downstream (tailrace).

### **2.2.1 Intake**

The selected intake type is a concrete overflow weir with Coanda screen intake design, suited for steep streams with high bedload. Coanda Screens use tilted wedge wire to divert water while allowing fish and debris to pass over the screen. The system allows a simple, low impact intake which requires little or no mechanical cleaning and has no moving parts or electrical requirements. The screens can operate efficiently in heavy debris-loading situations and are proven technology, with numerous installations in New Zealand and globally.

According to NIWA’s Fish Screening Guidelines<sup>4</sup>, these screens are essentially self-cleaning and have the ability to exclude very fine debris and small aquatic organisms. In recent years, this self-cleaning screen with no moving parts has been successfully used for debris and fish exclusion at several water diversions.

The intake is designed with crest level of 521.50 masl<sup>5</sup> for a discharge of 600 l/s through a 2.4 m wide Coanda screen. This discharge is associated with an upstream water level of 0.3 m above the Coanda crest at elevation 521.80 masl. An additional outlet is provided to allow water to flow over the rock banks on the downstream face of the intake to allow fish to pass the weir up and downstream even during low flow periods.

The weir is designed to pass the 100-year flood, estimated to be 15 m<sup>3</sup>/s (See Section 3.1.5). The flood discharge is passed over the weir using a 14 m long overflow section. Under a design flood of 15 m<sup>3</sup>/s the weir will pass the discharge with an estimated upstream water level of 0.6 m over the crest at a water level of 522.60 masl. Concrete abutments found the weir structure into the rock banks approximately 0.5 m to 1.0 m above this flood water level.

The total estimated length of the weir is 17 m long, from left abutment to right abutment. The pond area upstream of the weir is approximately 120 m<sup>2</sup>, with a volume at design water level (521.80 masl) of approximately 58 m<sup>3</sup>. The intake screen was selected with a 1.0 mm bar spacing, to provide protection for fish entrainment and exclusion of coarse sediment and bedload.

A 625 mm diameter pipeline would lead from the intake to a desander, to be constructed in a robust location downstream, above the riverbanks. The pipeline at the intake location would be encased in concrete to protect from floods and the river’s moving bedload. The desander is outlined in further detail in Section 2.2.2.

The intake civil works would be constructed in the dry and keyed into the natural rock at the site, utilising as much of the natural riverbed as possible, to reduce the size of the concrete structures. This is discussed in further detail in Section 2.2.1.1. The proposed overflow section features natural river rock on the downstream face. This is to allow fish passage, to protect the structure from bedload and to blend in with the natural environment.

To protect the fine screens on the Coanda, protective “grizzly bars” are proposed to deflect large rocks, trees and other debris – See Figure 3. Figure 4 shows indicative dimensioning of the intake. Figure 5 shows an example of a Coanda intake for a project designed for a larger flow than McCulloughs Creek Hydropower Project (1m<sup>3</sup>/s).

---

<sup>4</sup> NIWA 2007, Fish Screening: good practice guideline for Canterbury.

<sup>5</sup> Elevations in this section are based on values determined with handheld GPS and will be updated based on detailed survey.



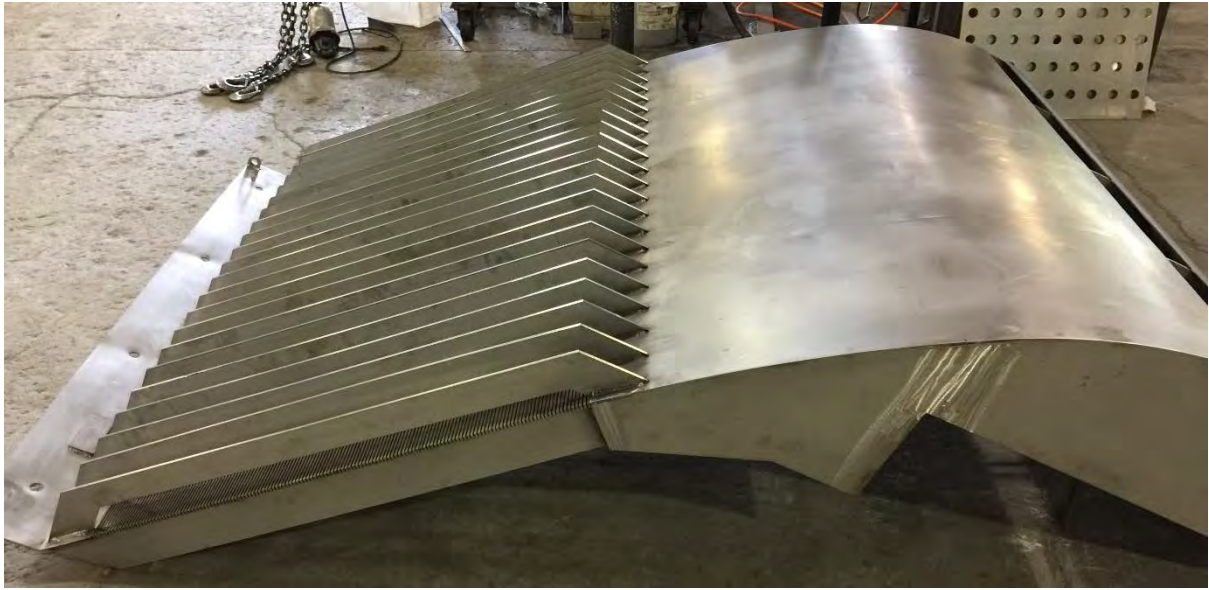

Figure 3 – Coanda screen with grizzly bars

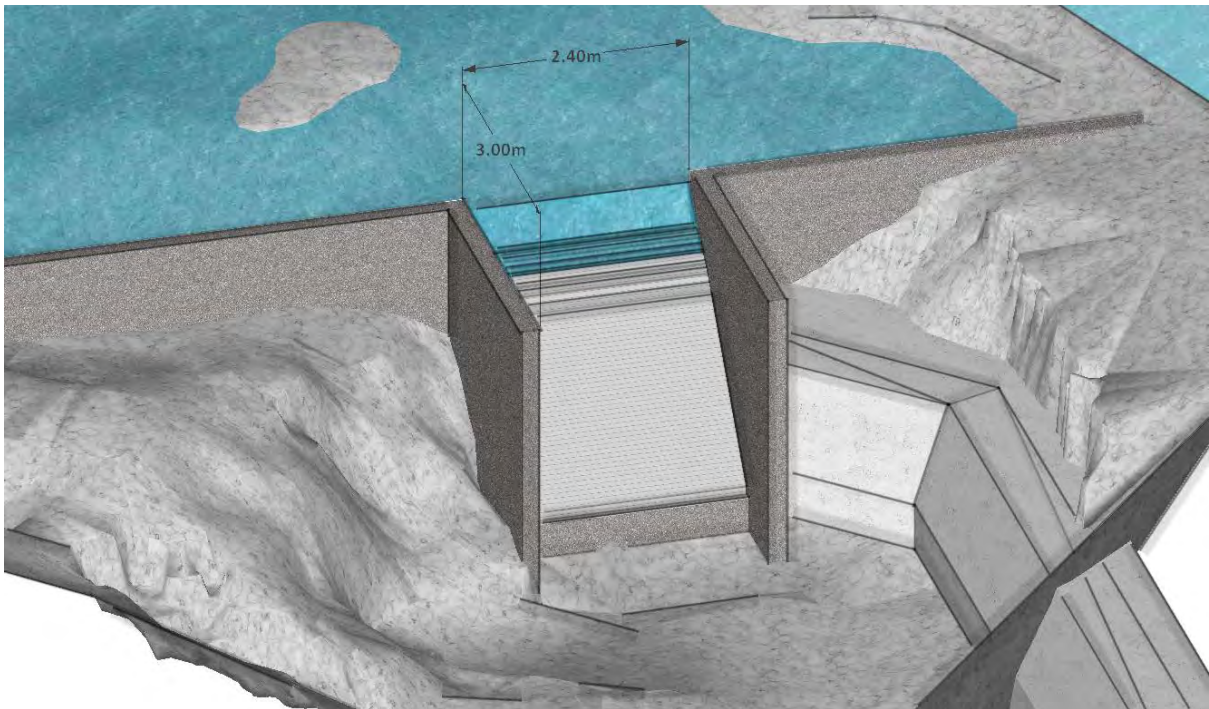

Figure 4 – Indicative dimensions of proposed Coanda intake and weir



Figure 5 – Example of a Coanda style intake

#### **2.2.1.1 Construction of intake**

The selected intake site on McCulloughs Creek features solid exposed bedrock and a natural drop of approximately 2.0 m. This feature allows the intake structure to be constructed with minimal excavation and adequately bonded to the rock using rock-anchors and grout. River gravel, boulders and sand would need to be removed from the river bed in places to expose the competent rock below. These aggregates may be able to be utilised in the concrete mix, with larger boulders used for placement on the downstream faces of the weir.

The intake site features a side flood channel, which would be used to bypass the flow around the dewatered section using sandbags during construction. Sandbags are preferred because they can be filled using in-situ sand and gravel and are low impact. Dewatering a section of riverbed is proposed during construction to allow placement of concrete formwork in the dry and limit the risk of contaminate discharge into the stream. A small pump would be used to control seepage into the dewatered area as required.

Construction of the intake would require a helicopter, cables and winches above the site and possibly a compact excavator. A simple helicopter pad and staging area is proposed on a rock outcrop approximately 30 m upstream. A cable-line from the helicopter pad to the weir site would allow safe transport of materials and equipment and facilitate heavy lifting where required. The compact excavator would be able to be broken down and flown in by helicopter if required.

Figure 6 shows the proposed location with the multiple channels visible and the dewatering sequence shown.



Figure 6 – Indicative plan of proposed weir and dewatering sequence

### 2.2.2 Desander

The desander is designed to remove sand particles down to 0.3 mm in diameter and provide a head pond with sufficient submergence for the main penstock. The design of the desander allows sediment to be flushed periodically back to the natural stream. Steel checker plate would cover the desander for both safety and debris and vegetation exclusion. A small spillway in the desander allows water to overflow back into the river in the event of a station trip.

The desander would be constructed using similar methodology to the intake, however as it is located above the river banks, no dewatering would be required.

Figure 7 provides an example of the desander proposed for the site.

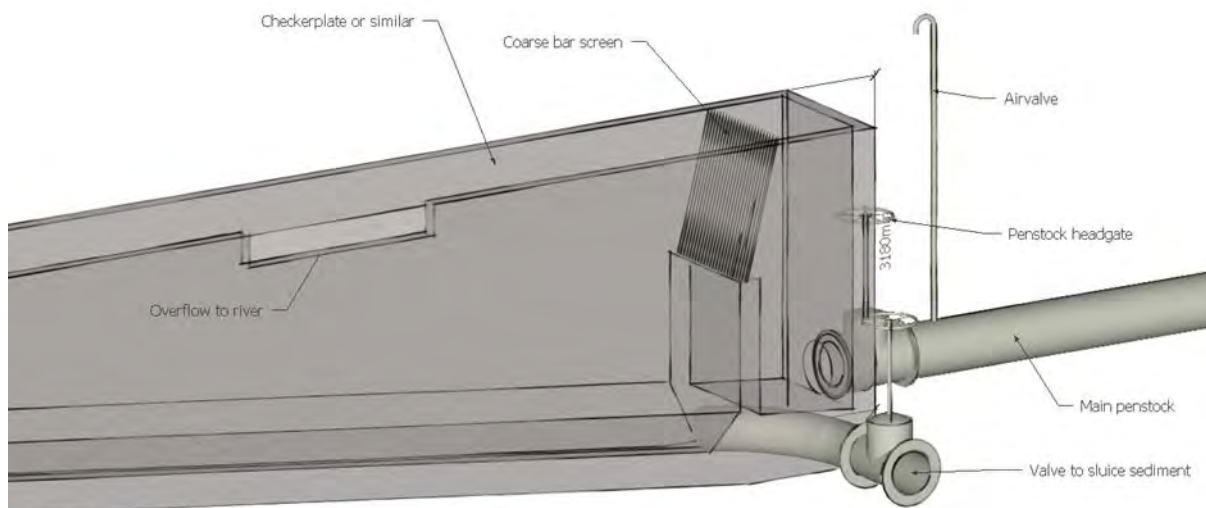

Figure 7 – Desander

### 2.2.3 Penstock

The penstocks for the scheme would be constructed above ground and not require excavation. The pipe would be anchored at various points with stakes and concrete anchors, where required. At river crossings, the pipe would span the crossing with a pipe bridge anchored on either bank. The pipe would be laid above ground on the access track without removing trees over 30 cm dbh. This is to keep the tree canopy intact and mitigate possible edge effects and wind throw risks. This approach is discussed in further detail in Section 4.2 - Effects on vegetation.

In areas where the penstock is near to the Alpine Fault, design elements would protect the scheme and surrounding environment in the event of fault movement. These elements will include appropriate jointing and support for the penstock, warning systems, automatic headgate controls at the intake and powerhouse to close the penstock, and consideration for drainage paths in the event of penstock rupture from fault movement.

The following sections describe in further detail both the low pressure, high-density polyethylene (HDPE) penstock (Section 2.2.3.1) and the high-pressure glass-reinforced plastic (GRP) and steel penstock (Section 2.2.3.2).

#### 2.2.3.1 HDPE (low pressure) penstock

From the desander, a 1,800 m long, 625 mm HDPE (High Density Polyethylene) penstock would carry flow of up to 600 l/s at a shallow grade, generally traversing the valley slope to a point at elevation EL 420 m. At this point, the HDPE pipe will be jointed to a GRP or steel penstock section – see Section 2.2.3.2 below. Average water velocity in the HDPE penstock at rated flow is 2.1 m/s.

The HDPE to GRP/Steel interface is required because the HDPE pipe is not rated for high pressures in the lower section of the penstock and GRP offers a higher-pressure rating. The static pressure in the GRP/steel section would range from 100 – 400 m head, with the design dynamic pressure marginally higher.

The advantage of using HDPE pipe is that it is flexible and is able to negotiate large canopy vegetation. In addition, the pipeline itself is pulled as a “string”, meaning it is welded together and winched through the landscape as one long section. Wholesale clearing of the forest in these areas is not required. Any clearing will be limited to small trees and shrubs where possible.

This approach allows minimal disruption during construction in the areas outside of the penstock alignment. Figure 8 provides an example of a similar diameter HDPE penstock.



Figure 8 - Example of HDPE penstock alignment

The HDPE penstock would be constructed above ground and not require excavation. The pipe alignment would be installed along the access path. The pipe would be anchored at various points where required with stakes and concrete anchors. At river crossings, the HDPE pipe would span the crossing with a pipe bridge anchored on either bank.

#### **2.2.3.2 GRP/Steel penstock section**

The GRP/steel penstock section would continue from the HDPE interface for approximately 910 m and connect to the powerhouse located at elevation 120 masl. The penstock would comprise sections of multiple pipe diameters, tapering toward the powerhouse. In the upper section of the high-pressure penstock, the pipe would be 550 mm diameter, tapering to 475 mm at the powerhouse. At the rated flow, the average velocity in the high-pressure penstock section ranges from 2.5 m/s to 3.4 m/s.

The proposed footprint width for the GRP/Steel penstock and access is 1.5 m. The proposed supports and thrust blocks are 750 mm to 1,000 mm wide, depending on required loading. The penstock is supported at 12.0 m centres and rests on a steel plate to reduce friction at the supports. Thrust blocks are required to resist the hydraulic forces from bends, both vertical and horizontal. The thrust blocks would comprise a block of reinforced concrete encasing the pipe, anchoring it strongly to the ground.

## 2.2.4 Turbine and Generator

The selected turbine for the project site is a Pelton turbine, an impulse style turbine designed to operate at high heads. The turbine consists of a runner with buckets to catch the high pressure jet of water, discharged from the turbine nozzle. The turbine is designed to have two jets to allow efficient operation over the range of flows experienced at the project site. Table 2 outlines the salient features of the turbine and generator for the project with dimensions for the unit shown in Figure 9.

The turbine ramping rates (the rate at which the flow rate through the turbines can change) will be based on the penstock constraints and consideration of downstream public safety. The ramping rates will be slow due to the long penstock and lack of storage and hence, will not pose a risk downstream.

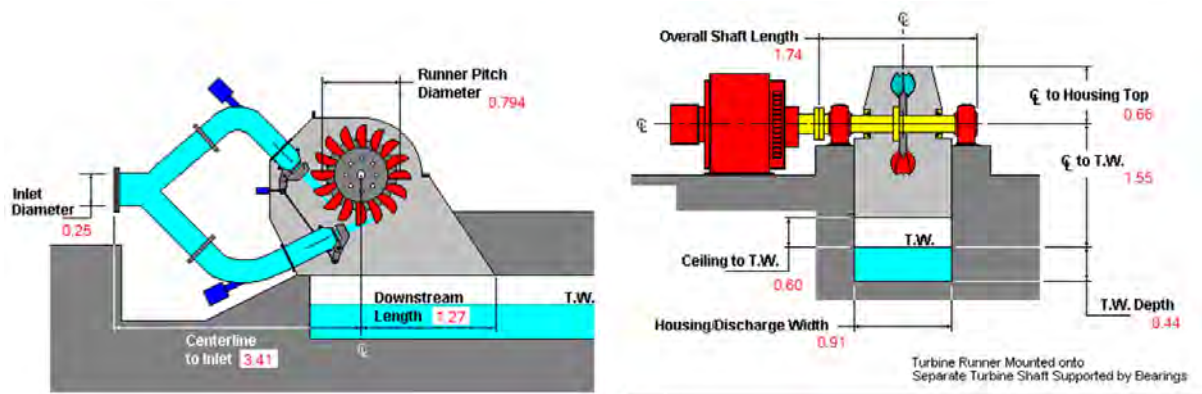

Figure 9 - Turbine and generator dimensions

The following table outlines the salient features of the turbine and generator.

Table 2 - Salient features of turbine and generator

Description	Value	Unit
Turbine type	Horizontal Pelton, 2 jets	
Design flow	600	l/s
Minimum Flow	60	l/s
Rated net head	377	m
Installed capacity	1886	kW
Efficiency at rated flow and net head	90.3%	
Runner diameter	794	Mm
Nozzle diameter	210	mm

## 2.2.5 Powerhouse and tailrace

The proposed powerhouse location is at elevation 120 masl. At this point, water would flow back via the tailrace into McCulloughs Creek and discharge naturally to the Whataroa River, another 1.5 km downstream. The proposed elevation of the powerhouse has been set to approximately 5 – 10 m above the normal water level and above the 100-year return period water level, avoiding flood risk. The exact levels will be determined from hydraulic modelling during the design phase.

The powerhouse would be constructed with a common colour steel garage on a simple concrete footing. Figure 10 presents an example of the style and dimension of building proposed. The powerhouse colour would be selected to blend in with the environment, likely dark green. The approximate dimensions of the building would be 7.0 m x 6.0 m. A small transformer would be located adjacent to the powerhouse where it would feed an 11 kV line, which would connect the scheme to the Westpower Network.

Because the powerhouse and tailrace are to be located a significant elevation above the river and are not hydraulically connected to the river, there is no risk of fish entering the tailrace or turbine workings. This is shown schematically below in Figure 11.



Figure 10 – Approximate dimension and style of powerhouse

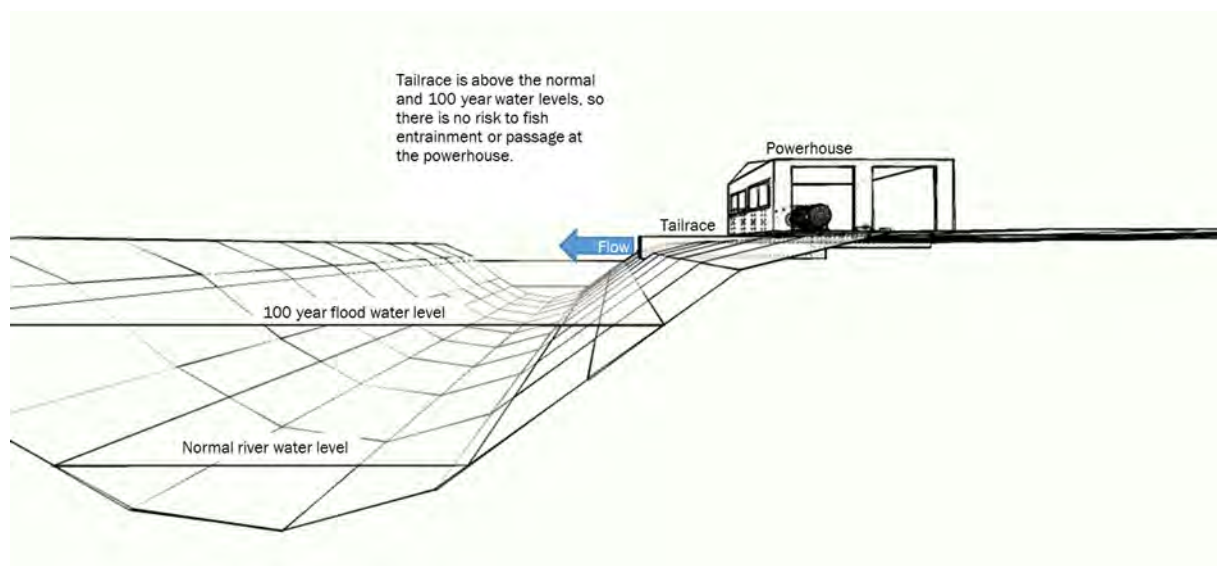

Figure 11 – Example of Pelton turbine powerhouse and tailrace above river water level

## 2.3 Access

No.8 Limited will avoid the use of roads for construction of the project, apart from the road to the powerhouse itself. Instead, in keeping with the principles of building a low impact hydropower scheme, a cableway will be used to construct significant portions of the scheme.

In order to construct the intake and penstock, No. 8 is proposing to use a cableway and helicopters for construction. This construction method would allow the delivery of cement, aggregates, steel and pipe to the intake site where contractors who could access the site via foot would install them. If required, a small excavator such as a bobcat would be used to assist in moving pipe lengths and equipment. This would be transported via the cableway, or by helicopter.

This track would resemble a typical hiking route (Refer Section 1.1.5) in New Zealand bush and would be constructed in a way that would not affect the forest canopy. This approach would be achieved by avoiding vegetation with a dbh (diameter at breast height) of 30 cm or more in order to mitigate potential edge effects and wind throw risks.

The upper part of penstock alignment will be HDPE welded together and pulled along the ground through the forest track with winches and cable. This is the typical method of transporting and installing plastic pipe. The lower penstock (high-pressure) section will be installed by making use of the cableway. In typical West Coast forest, tracks of this scale (1.5 m to 2.0 m wide) are generally obscured from view by the thick high canopy of native NZ trees – This would appear to be the case at the project site.

A number of construction projects in New Zealand and across the world have utilised these methods for construction in remote areas. Low impact construction using helicopters and cableways is frequently used for the remote hydropower work, mining, forestry and installation of power pylons. This methodology is in keeping with 1.1- Principles for developing a low impact hydropower scheme, in particular principal 1.1.4 - Avoiding removal of large areas of native bush.

### 2.3.1 Temporary construction access

In keeping with Principal 1.1.4, No. 8 Limited intends to install a temporary cableway to construct the scheme. The cableway will be constructed directly above the penstock alignment to allow the transport of materials and pipe to where they need to be installed. As mentioned in the earlier section, the temporary construction access would be provided without removing vegetation with a dbh of 30 cm or more in order to mitigate potential edge effects and wind throw risks.

The proposed design of the system allows loads of up to 750 to 1,200 kg to be aerially transported. To put this in perspective, each length of pipe is around 230 kg and a compact excavator (if required) is around 1,050 kg. The cableway would be fitted with a crane from a company such as LCS<sup>6</sup> or Seik<sup>7</sup>, who specialize in cableway construction for hydropower schemes. Once construction is complete, the cableway would be removed and vegetation allowed to regenerate in areas not used by the scheme.

---

<sup>6</sup> <http://www.lcs-cablecranes.com/areas-of-work/hydro-power-projects/>

<sup>7</sup> <http://www.seik-cableway.com/index.php?lang=en>



The proposed width of the construction access clearing is 1.8 m to 2.0 m, allowing approximately 0.7 m for the penstock, and 1.0 m to 1.3 m for construction and temporary access. After construction, the shoulder of the path and laydown areas will be allowed to regenerate with lower level vegetation, noting that the canopy would be left intact along the alignment. This would allow an operator or maintenance crew access to the penstock and intake, but allow the bush to recover as much as possible.

The following image is an example of a cableway being used for construction of a steep hydropower penstock. However, in this image the pipe is steel and significantly larger than that proposed for the McCulloughs Creek Scheme. The penstock is also buried in the photo, whereas No.8's proposal uses above ground pipe, supports founded to rock and does not result in removal of forest canopy.



*Figure 12 – Example of cableway used for penstock construction*

### **2.3.2 Access to Highway 6**

The proposed access from the main highway is to use an existing embankment which can be used to access the paddock and marginal strip. The access is in the NZTA right of way, and would extend to the marginal strip. Along the highway, there are frequent examples of embankment access such as that proposed.

Generally, construction vehicles would be utility vehicles or small trucks which require a turning radius of approximately 5 to 7 m. This radius is consistent with farm access driveways and the like, which use similar turning circles. Sight distances at the location are sufficient to allow other traffic to see, prepare and stop in the required distance.

Specific detail (aggregate type, slopes, grades, turning circles) about the access would be provided by the construction contractor, to ensure the access is to specification. The proposed access from the highway is illustrated in Figure 13.

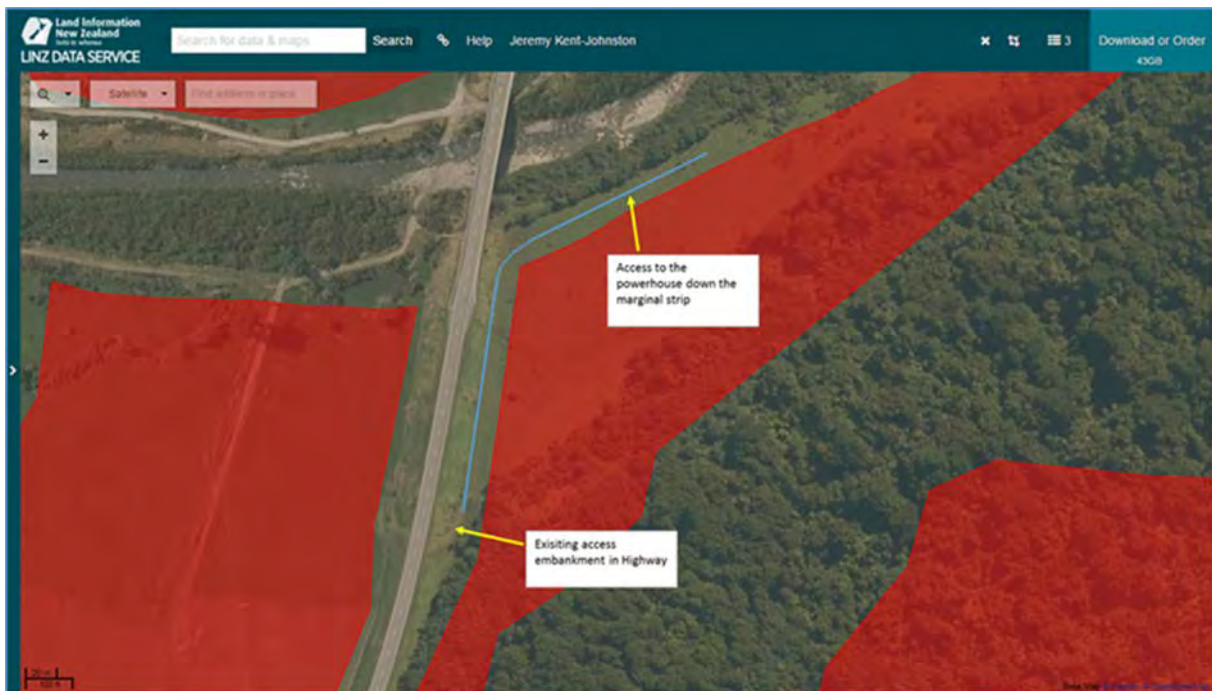

Figure 13 – Access from highway

### 2.3.3 Cableways used for construction

Cableways are a useful and well established method for transporting goods, especially in steep and remote areas. The cableway construction methodology is common in the forestry industry (cable-yarding) and there are well established standards to ensure that the method is safe, well planned and effective. For example, *Guide to Managing Risks in Cable Logging, Safework Australia, (2013)* outlines safe practice for cable yarding and cableway use.

The cableway length for the McCulloughs Creek Hydropower Project has been reduced to 500 m long (originally 750 m) to reduce the effects during construction - see Section 4.6.3. The cableway would be fixed to supports comprising steel lattice trusses at either end. The supports will be mounted on concrete block foundations connected to the rock below, which will also serve as a penstock thrust block once completed.

The lattice trusses will be 5.0 m to 10.0 m tall, so will be comparable or lower than the existing forest canopy. The lattice trusses will be temporary (construction phase only) and supported by guy ropes attached to stable trees or dead-man anchors as required.

A number of intermediate supports may be used to guide the cable along the penstock alignment and allow for changes in direction and slope. These intermediate supports will be secured to trees and rock anchors at appropriate locations. This approach is proposed so that No.8 Limited does not need to clear a large corridor along the alignment. An example is shown in the image below, noting that the cableway is dragging logs, as opposed to fully lifting pipe lengths.

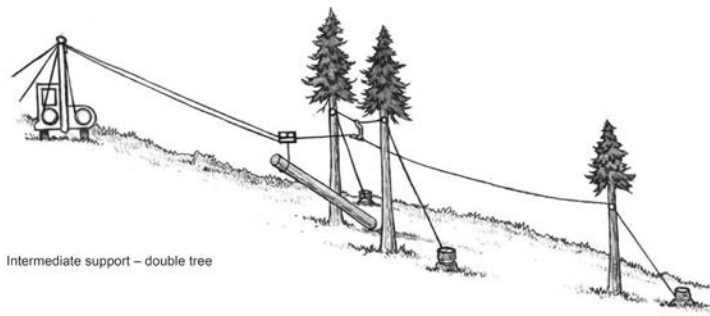

Figure 14 – Intermediate support example

Winches will hoist pipe lengths and construction material slowly up the cable, at walking pace (0.5 m/s – 1 m/s). This speed is proposed for safety reasons and ensures that the contractors would be able to observe and control the payload. It also would allow a narrower corridor than if a fast-moving cableway was used.

#### 2.3.4 Permanent access

The permanent access track similar to a DOC route will run alongside the penstock alignment to allow foot access during operation. Access by foot would be sufficient to inspect and operate the scheme. For example, to undertake inspection of the intake after flood events or to check slips, debris loads or blockages. Further detail about the dimensions of the access track is provided in Figure 15.

In the event that heavy lifting is required, for example, pipework needs to be replaced or repaired, three methods would be available, depending on the significance of the works:

1. helicopter,
2. mini excavator flown into the site, or
3. re-instatement of the cableway temporarily.

The proposed helicopter pad and staging area (30 m upstream of the intake) would allow access to the intake and upper penstock location. A cable line from the helicopter pad to the weir site will allow safe transport of materials and equipment and facilitate heavy lifting where required.



Figure 15 – Dimensions of penstock access track

## 2.4 Scheme footprint and required clearing

This section describes cleared areas to allow construction and operation of the project. It should be noted that clearing refers the removal of smaller vegetation below a dbh of 30 cm. Trees larger than this and forming part of the canopy would be left intact as much as is practicable, to mitigate both visual and ecological effects.

The footprint for each component of the proposed scheme is outlined in Table 3. The total cleared area required for the proposed scheme is 4,981 m<sup>2</sup> or approximately 0.5 ha. The largest permanent cleared area is the penstock corridor, and the largest temporary cleared area (allowed to regenerate) is the lower cableway support and laydown area.

The area of the bush permanently cleared in the Waitangi Forest is approximately 572 m<sup>2</sup>. Clearing in this parcel is required for the:

- HDPE pipeline,
- desander, and
- intake laydown area and helipad (temporary and consisting of indigenous grasses, sedges, herbs, ferns and other seedlings and shrubs ).

The area of the bush cleared permanently in the Whataroa Scenic Reserve is approximately 3,327 m<sup>2</sup>. Clearing in this parcel is required for the:

- Penstock (GRP/Steel) corridor,
- Powerhouse,
- Tailrace,
- HDPE pipeline,
- Lower cableway support and laydown area (temporary),
- Upper cableway support and laydown area (temporary), and

The area of the bush cleared permanently in the Marginal Strip is approximately 1,082 m<sup>2</sup>. Clearing in this parcel is required for the access road and transmission line. However, much of this land is already cleared so would not require further removal of flora.

Table 3 – Areas of land permanently cleared (after regeneration) for proposed scheme

ID <sup>1</sup>	Component	Area in Waitangi Forest	Area in Whataroa Scenic Reserve	Area in Marginal Strip	Cleared area – permanent <sup>2</sup>
		m <sup>2</sup>	m <sup>2</sup>	m <sup>2</sup>	Hectares
1	Lower cableway support and laydown		450		0.045
2	Penstock (GRP/Steel)		2028		0.203
3	Powerhouse		75		0.008
4	Tailrace		20		0.002
5	Upper cableway support and laydown		13		0.001
6	Intake laydown area and helipad	219			0.022
7	Access - Option 1		652	1,082	0.173
9	HDPE Pipeline	254	90		0.034
10	Desander	100			0.010
<b>TOTALS</b>		<b>572 m<sup>2</sup></b>	<b>3,327 m<sup>2</sup></b>	<b>1,082 m<sup>2</sup></b>	<b>0.5 Ha</b>

<sup>1</sup> This ID is referenced to the components shown in the Appendix A drawings

<sup>2</sup> This refers to small, non-canopy vegetation below a diameter at breast height of 30 cm

#### 2.4.1 Construction sequence and methodology

The general procurement approach for the construction of the project will comprise three separate packages – An enabling works contract, a civil works contract and an electro-mechanical works contract.

The intention would be to award the Civil Works contract to a local contractor with good knowledge of the West Coast environment. No.8 Limited has identified a number of contractors who have been recently involved with hydropower and mining construction projects and would be likely candidates.

The electro-mechanical contract would be a “water-to-wire” package from a reputable turbine/generator vendor. This type of contract is a fixed price contract where the vendor supplies and commissions the turbine, generator, SCADA, control system and instrumentation. The advantage of using this style of contract is that there are guarantees that the equipment will communicate properly and operate as intended.

#### **2.4.1.1 General construction sequence**

The following section outlines the intended construction sequence for the project using the aerial cableway.

1. The initial access road will be laid to the powerhouse area,
2. The powerhouse area, the lower laydown areas, penstock alignment and access track will be cleared to allow access to the upper laydown area and construction of the powerhouse,
3. Construction will begin on the powerhouse and lower penstock alignment by conventional construction methods, accessing the site by the road access,
4. A helicopter will install the concrete footing for the cableway at the upper laydown area and conventional equipment will construct the lower footings,
5. The cableway will be installed, using a helicopter to lift the intermediate truss supports and guy ropes into position and take concrete and materials for the upper cableway station. The cable will be either installed by hand, using multiple labourers to lift loops of cable up the slope or by helicopter as required,
6. Once the cableway is installed, all construction material, machinery and pipe lengths will be transported via this method,
7. The HDPE penstock section will be constructed by ferrying materials via the cableway and compact excavator to the construction area. Additional equipment may be brought in by helicopter as required,
8. Once construction is completed, the cableway will be removed and stored so that it can be re-installed later as required, and
9. The remaining components of the project can then be installed and commissioned.

#### **2.4.2 Interconnection to Westpower Network**

The connection to the distribution system would be at the nearby 11 kV network owned by Westpower. The distribution line (shown in Appendix A) runs alongside State Highway 6, with the closest zone substation approximately 5.5 km away in Whataroa. No.8 Limited has had positive discussions about the scheme with Electronet/Westpower regarding connecting the scheme and its ability to operate within the parameters and constraints of their network. The exact details of the proposed grid connection are subject to the outcome of a connection study with Westpower/Electronet.

In the Whataroa Scenic Reserve, No.8 proposes to bury the distribution line in a conduit. This is to reduce the visual effects of a line installed on above ground poles. When the distribution line reaches the marginal strip, the line would be installed on poles again and interface with the Westpower System.



Figure 16 - 11 kV Westpower distribution line

## 2.5 Desired Corridor for DOC Licence

No.8 proposes to use a corridor approach in the DOC Concession Application. This is because a number of aspects on the project are subject to site-specific conditions, currently unknown. For example, the location of significant flora or habitat may require the penstock alignment to be altered to avoid these features. Detailed topographical surveys will be undertaken and the accurate data will require the final alignment of project components to adjust accordingly.

The scope of this project reflects an effort to achieve the desired outcomes outlined in the *DOC Conservation Management Strategy*<sup>8</sup>, specifically for the *Te Wāhi Pounamu Place*.

If a concession is granted to No.8 Limited and once site investigations were completed, the boundary of the DOC Concession could be redefined to a smaller footprint. Currently the corridor allows for some flexibility in the siting of intake and penstock alignment, to reduce the effects of the project. This is in keeping with 1.2- Principles for developing a low impact hydropower scheme.

Figure 11 presents the desired location of the application corridor.

---

<sup>8</sup> <http://www.doc.govt.nz/about-us/our-policies-and-plans/conservation-management-strategies/west-coast/4-desired-outcomes/>



Figure 17 –Proposed Corridor for Concession Application

## 2.6 Potential for improvements to access and scenic values

No.8 Limited proposes to provide public access to the penstock alignment route, with the intention of accessing a lookout area at the top, near elevation 500 masl. This would be a magnificent walk, climbing 400 m in elevation with spectacular views west, across the Whataroa farmland.

Figure 17 shows a view due west, and approximates the view from the proposed lookout location. Figure 18 shows the view from approximately 500 masl, looking southwest towards the Whataroa River, with McCulloughs Creek confluence at the right of frame. The penstock alignment would be oriented following the steep ridge in the left of frame. A lookout at the summit of that ridge would offer spectacular views.

The proposed route would be similar to that at Pioneer Generation’s Wye Creek<sup>9</sup> hydropower scheme, where there is a public access route alongside the penstock, so that the public can access the area and experience breath-taking vistas of southern Lake Wakatipu. Figure 19 shows a view from this track with hunters descending and the author enjoying the view. The penstock for the McCulloughs Creek Scheme is similar in diameter as that shown in this image.

<sup>9</sup> <http://www.doc.govt.nz/parks-and-recreation/places-to-go/otago/places/remarkables-conservation-area/things-to-do/lower-wye-creek-track/>





*Figure 18 –View from near the proposed lookout location*



*Figure 19 –View from near the proposed lookout location*



Figure 20 –View from penstock route on Wye Creek Scheme (Pioneer Generation) in Central Otago

## 2.7 Property ownership

The property ownership is shown on Figure 20. The entire scheme would be located on DOC Conservation Land, specifically, the Waitangi Forest Conservation Area and the Whataroa Scenic Reserve. The proposed location for the access route and low voltage (11 kV) connection to the grid are in the Marginal Reserve along the banks of the river in order to minimise effects to the Whataroa Scenic Reserve. The neighbouring farmland is freehold land owned by Brian Keith Blackburn and Jacqueline Ivy Blackburn. The closest property to the project is the approximately 500 m away.

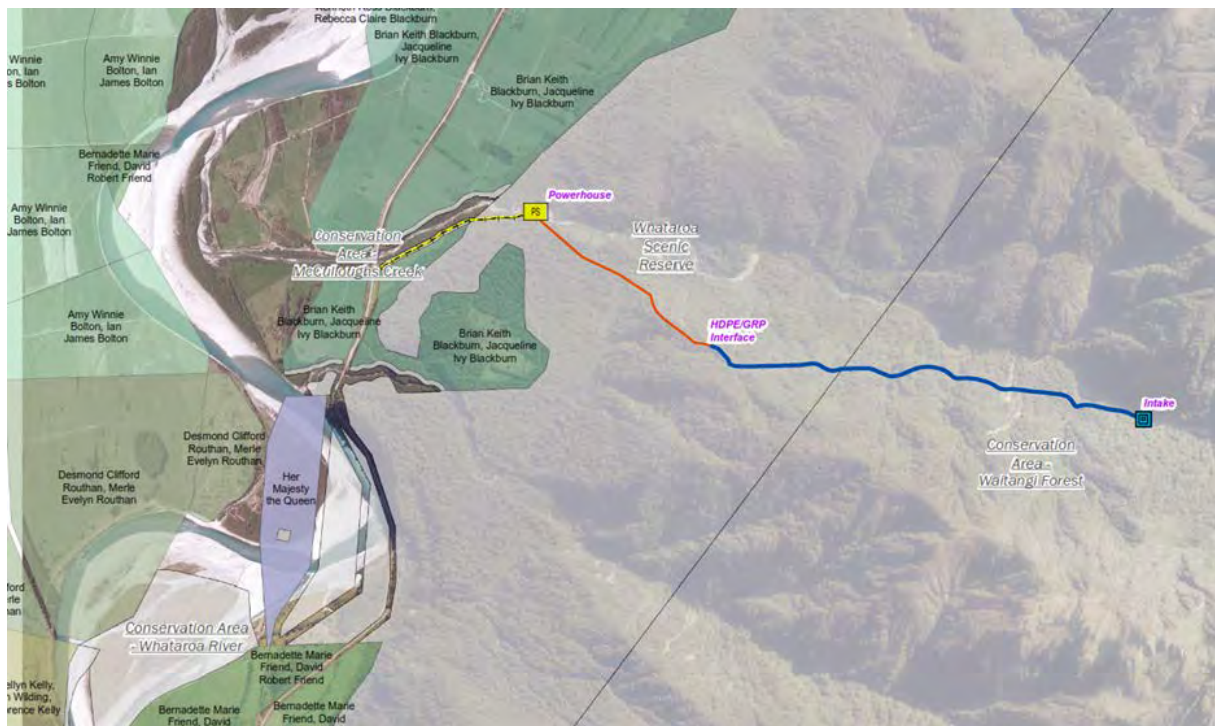

Figure 21 –Property Ownership near McCulloughs Creek

## 2.8 Employment

Once designed, the scheme construction phase would be split into three work packages. The packages would consist of individual contracts for preliminary works, civil works and electro-mechanical works. For all the contracts, local contractors will be utilised as much as is practicable. This approach is aimed at benefitting the West Coast in general with local labour used for on-going operations and maintenance works.

The scheme will be operated in an unmanned manner, meaning that the turbines and equipment will essentially operate themselves. There will be a requirement for part time maintenance personnel to ensure that the station is maintained and minor repairs are made. For example, after a flood, the intake and desander may need to unblocked or cleaned to ensure that they can operate as designed.

No.8 Limited aims to engage these personnel from the local area, with the intention of offering long-term employment. A hydropower scheme benefits significantly from station personnel developing an intimate working knowledge of its operation. During commissioning and early operation, Westpower/Electronet would be involved to ensure that the station was connected properly and operating as per the Electricity Code and their network requirements.

### 3 The Natural Environment

According to the CMS, Te Wāhi Pounamu is one of the most important areas on the West Coast Te Tai o Poutini for biodiversity. This is because of a number of factors, such as the wide range of ecosystems and the existing natural condition.

The McCulloughs Creek project site is located on the eastern flanks of the Adams Range. McCulloughs Creek rises on the southeast side of Mt Adams and flows in a west-south-west direction before turning due west and joining the Whataroa River.

In the upper reaches, McCulloughs Creek flows through steep sided valleys, characterised by near-vertical rock walls and large waterfalls. The riverbed itself contains large scattered boulders, some larger than cars. Once the river begins to flatten out, near elevation 150 masl, the river begins to become gentler. At around elevation 100 masl, the river enters farmland, and is relatively flat, with a riffle-run-pool sequence occurring. At that point, it flows at an even grade through a narrow marginal strip, under SH 6 to its confluence with the Whataroa River.

Figure 21 shows a view of the farmland, with McCulloughs Creek Bridge on SH6 in the distance. Westpower's two 3-phase distribution circuits are shown at the left of frame.

The sides of the valley at the site location are steep and are covered by dense native bush. In a number of places, flood channels are present through the bush and allow for easier access through the bush in low flow periods.

Access to the intake location is challenging and to get there takes approximately five hours on foot, following the river and using the bush where the river becomes impassable. The return trip takes approximately four hours by following the same route. The site appears to be untouched from a human point of view.



Figure 22 – Whataroa Farmland near the McCulloughs Creek crossing

### 3.1 Hydrology

McCulloughs Creek rises on the south-eastern flanks of the Adams Range on the West Coast, South Island, New Zealand, near the township of Whataroa. The river flows in a west-south-west direction before turning due west near the Alpine Fault, joining the Whataroa River near SH6.

The McCulloughs Creek catchment climbs to elevations of approximately 1500 masl, with the main peak at the head of the valley climbing to 1870 masl. The size of the catchment at the proposed intake location is 4.49 km<sup>2</sup>. The river flows from alpine sources, through a steep sub-alpine section, dropping rapidly over a series of waterfalls and rapids to around 100 masl. From that point, the river flows over gentle pasture for approximately 1.5 km to the confluence with the Whataroa River.

Figure 23 presents an image at two river locations, one in the flat farmland reach and the other in the lower sub-alpine reach. Figure 23 shows an image looking downstream from the proposed intake site, showing the steep, fast flowing creek scattered with boulders and coarse gravels.

In order to understand the flow regime at the site, a hydrological assessment was undertaken. Two sources of hydrological data were used in the assessment:

- No.8 Limited engaged NIWA to install and operate a permanent gauging location in McCulloughs Creek to acquire time series flow information from the river.
- A representative gauging station (Poerua Gauge) was used to derive a flow estimate for the project site. This catchment of this gauging station is much larger than the McCulloughs Creek site, which may lead to inaccuracies in estimates.

The approach taken to estimate flows is discussed in further detail in Section 3.1.3.



Figure 23 – Left: View upstream in flat farmland reach of the river (EL 100 m). Right: View upstream in the steeper sub-alpine reaches of the creek (EL 200 m).

### 3.1.1 Rainfall

Figure 24 shows the mean annual rainfall at NIWA rainfall stations<sup>10</sup> near to the project site. Plotted on the chart are the elevations of the gauges, showing the effect of elevation on the mean annual rainfall. Areas of higher elevation experience significantly more rainfall than low-lying areas. The gauging site on McCulloughs Creek is estimated to have approximately 4,600 mm of rain per year at an elevation of 110 masl. The intake site on McCulloughs Creek is estimated to experience approximately 4,900 mm of rain per year at an elevation of 520 masl.

---

<sup>10</sup> The National Climate Database, NIWA - <http://cliflo.niwa.co.nz/>



*Figure 24 – View looking downstream from the proposed intake site*

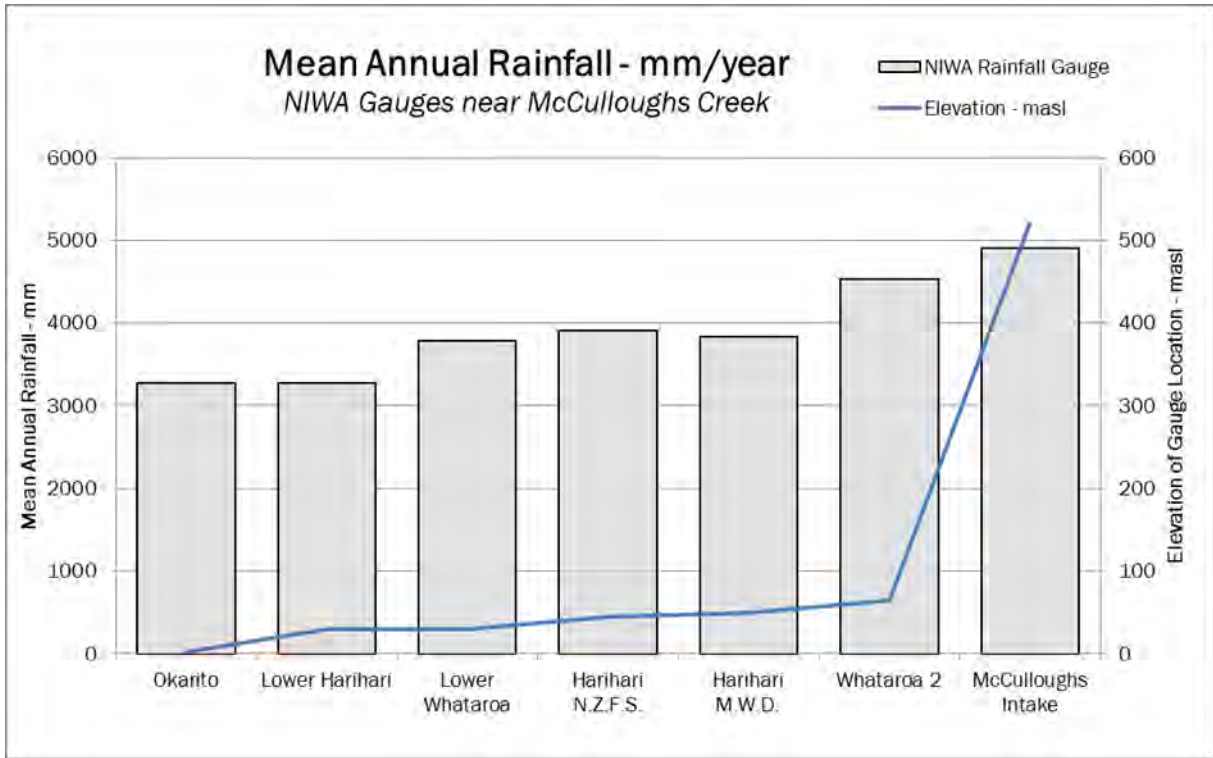

Figure 25 – Mean Annual Rainfall at Gauges near McCulloughs Creek Intake

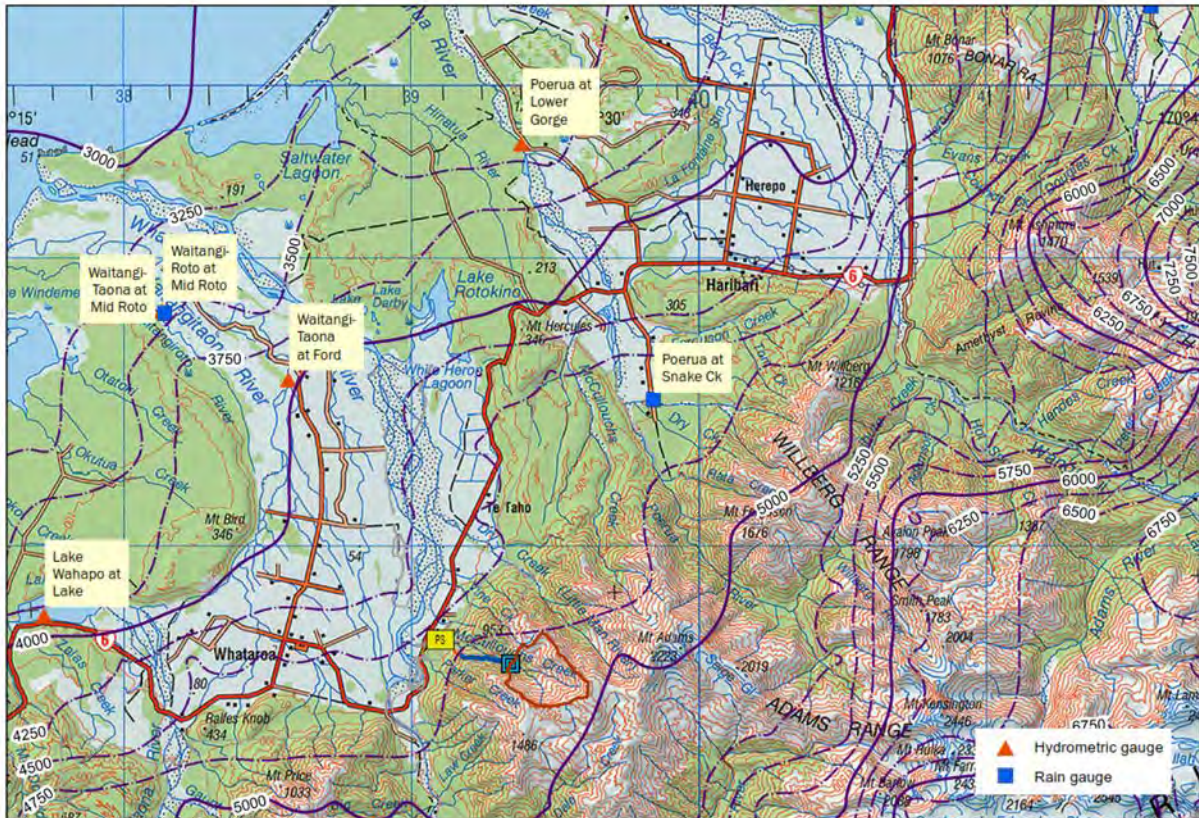

Figure 26 – Map showing NIWA rain gauges, hydrometric gauges and rainfall isohyets



### 3.1.2 Installation of flow gauging

The difference in catchment size between the Poerua gauge and the McCulloughs Creek intake site will mean flow estimates will have uncertainty/error, especially around low flows.

On 2 March 2016, No.8 Limited engaged NIWA to install and manage a flow gauging station on McCulloughs Creek to gain more certainty over the flow regime in the creek. The gauge site is located near the powerhouse location, for ease of access. As there are no other significant tributaries upstream of this location, proration of flows for the intake location is appropriate. The gauge site itself is located at coordinates -43.262918°, 170.425227° (Latitude, Longitude, WGS84). An image of this location is shown in Figure 26 and the control cross section at the gauge location is presented on Figure 27.



Figure 27 – Gauge site location

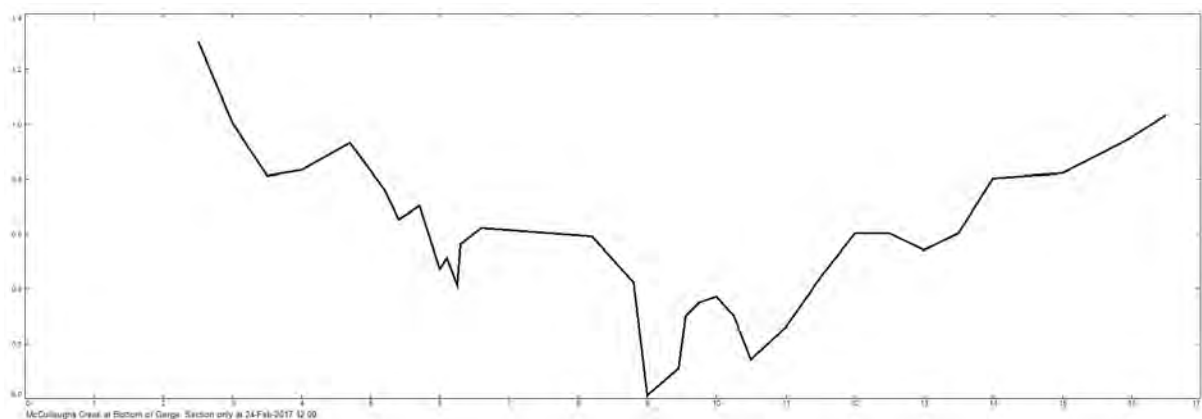

Figure 28 – McCulloughs Creek Control Cross Section

### 3.1.3 Hydrometric gauging and flow proration

NIWA operates a number of gauges in the vicinity that were used to generate an estimate of the flows in McCulloughs Creek. The neighbouring gauges and their locations are presented in Figure 25 and shown by the red triangles. Catchment information and actual flow gauging data in McCulloughs Creek was also used to correlate the two sites.

The *Poerua at Lower Gorge* gauging station was selected as the representative gauge for the project site because:

- The site is on an unregulated catchment, with no lake storage or hydropower activity,
- The site has 11 years of record, significantly more than the other sites, with the exception of Lake Wahapo, and
- In the upper reaches, the Poerua River flows from a similar catchment in terms of aspect and land cover.

The site and associated data have a number of limitations however:

- The McCulloughs Creek intake site catchment area is 3.2 % of the Poerua at Lower Gorge catchment area, and is hence considered a large difference,
- The Poerua at Lower Gorge site has experienced several washouts, changes in river rating due to floods and multiple location changes. NIWA has attempted to maintain the integrity of the discharge information by making necessary adjustments, but the quality of the record is variable, and
- The gauge site is no longer operated.

#### 3.1.3.1 Catchment areas for respective sites

Table 4 outlines the catchment size and annual rainfall depth for the Poerua gauge and the McCulloughs Creek at gauging and intake sites. The source for the gauge, catchment and rainfall data is NIWA<sup>11</sup>. The catchment details for the McCulloughs Creek site have been calculated using the Spatial Analyst toolbox in ArcGIS and an 8 m DEM<sup>12</sup> of the area. Figure 28 shows the catchment area of the proposed intake site. The area and rain factors are both based on the difference with the McCulloughs Creek sites to the Poerua River i.e. [ B / A ] and [ C / A ].

Table 4 - McCulloughs Creek catchments and Poerua at Lower Gorge gauge site

ID	Location	Catchment	Rainfall	Area Factor†	Rain Factor†
		km <sup>2</sup>	mm/year	%	%
A	Poerua at Lower Gorge	147.6	3,840	-	-
B	McCulloughs Creek gauge site	7.5	4,600	5.1 %	120 %
C	McCulloughs Creek at intake	4.4	4,900	3.0 %	128 %

<sup>11</sup> <https://sims.niwa.co.nz/sims/stations.do>

<sup>12</sup> This 8m Digital Elevation Model (DEM) was originally created by Geographx ([geographx.co.nz](http://geographx.co.nz)) and was primarily derived from January 2012 LINZ Topo50 20m contours ([data.linz.govt.nz/layer/768](http://data.linz.govt.nz/layer/768)).

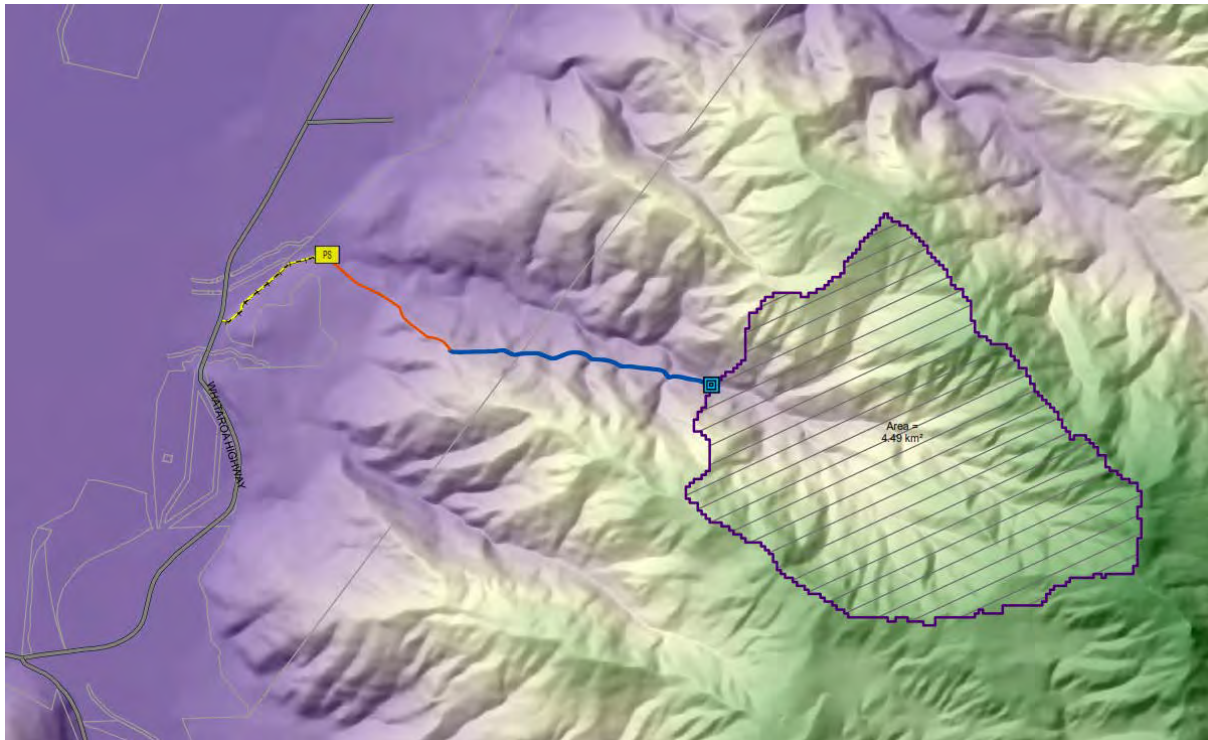

Figure 29 – Map showing McCulloughs Creek Hydropower Scheme and catchment at the intake site

### 3.1.3.2 Actual flow gauging comparison

Five actual flow measurements over the same period were taken by NIWA to determine correlation of the Poerua River (at the old gauge site) and McCulloughs Creek. This correlation was used to provide a second point of reference for comparison of the catchments.

The catchment area at the McCulloughs Creek intake site is 59% of the gauge site catchment. Therefore, the gauge flows were prorated by 59% to generate a flow estimate of the flows at the McCulloughs Creek intake site. As mentioned, there are no significant tributaries into the creek between the gauge and intake sites, so this method is considered robust.

Table 5 below shows proration factors from the five manual gauging visits and the dates of when the gauging occurred. The proration factor is calculated by taking the intake site flow and dividing by the Poerua River flow rate.

Table 5 – Actual flow measurements on McCulloughs Creek and Poerua Gauge site

Date	Poerua River	McCulloughs gauge	McCulloughs intake	Proration Factor (Intake/Poerua)
	m <sup>3</sup> /s	m <sup>3</sup> /s	m <sup>3</sup> /s	%
2/03/2017	8.021	0.642	0.484	4.9%
21/03/2017	7.484	0.663	0.390	5.2%
4/05/2017	9.785	0.823	0.377	4.7%
14/07/2017	8.38	0.703	0.413	4.9%
24/08/2017	14.43	1.006	0.591	4.1%
Average proration factor				4.8%

### 3.1.3.3 Final Proration Factor

The final proration factor was used to determine a time series estimate of flows in McCulloughs Creek at the intake site, based on historical gauge data on the Poerua River. This proration was based on an average of the area and rainfall factor (Section 3.1.3.1) and factor derived from the manual readings (Section 3.1.3.2) on Poerua River and McCulloughs Creek.

Table 6 – Final Proration Factor

Location	Area	Rainfall	Factor for proration
Based on catchment area and rainfall	3.0 %	128 %	3.8 %
Based on manual readings	-	-	4.8 %
Average based on 2 methods		4.3 %	

### 3.1.4 Average flow and flow series data

#### 3.1.4.1 Annual average flow

To determine an estimate of the average annual flow at the McCullough Creek intake, the Poerua River gauge data was scaled using the final proration factor above. Using this method, the estimated annual average flow at the intake location is 1,300 l/s (1,294 l/s).

Using the NIWA REC V2<sup>13</sup> (River Environment Classification Version 2) as another reference, the average flow estimate was determined to be 1,108 l/s (NZSegment ID = 12114915).

These two methods show reasonable agreement and the representative average flow estimate was determined by taking the lower of the values. This is justified because the flood discharge on the Poerua River is likely to be larger due to snow pack in the upper reaches and a larger overall catchment. These large floods will skew the average flow estimate upwards. The representative average flow at the intake site is assumed to be 1,108 l/s.

The six months of data from the installed gauge show an average flow of 995 l/s for the period March to August 2017.

#### 3.1.4.2 Flow series

To determine an estimate of the flow series, the Poerua River gauge data was scaled using the final proration factor above. Figure 29 shows the time series of recorded flows for the median, wettest and driest year (based on annual average flow) in the data, prorated to the McCulloughs Creek intake site. Figure 30 presents the flow duration curve at the McCulloughs Creek intake showing the percentage of time that a given flow is exceeded on the x-axis.

As discussed in Section 3.1.3, No.8 Limited installed and operates a hydrometric gauge at the powerhouse location. Over the longer term, this data will be used to supplement, calibrate and eventually replace the flow series calculated in this section.

---

<sup>13</sup> <https://www.niwa.co.nz/freshwater/management-tools/publications-for-water-managers/river-environment-classification>

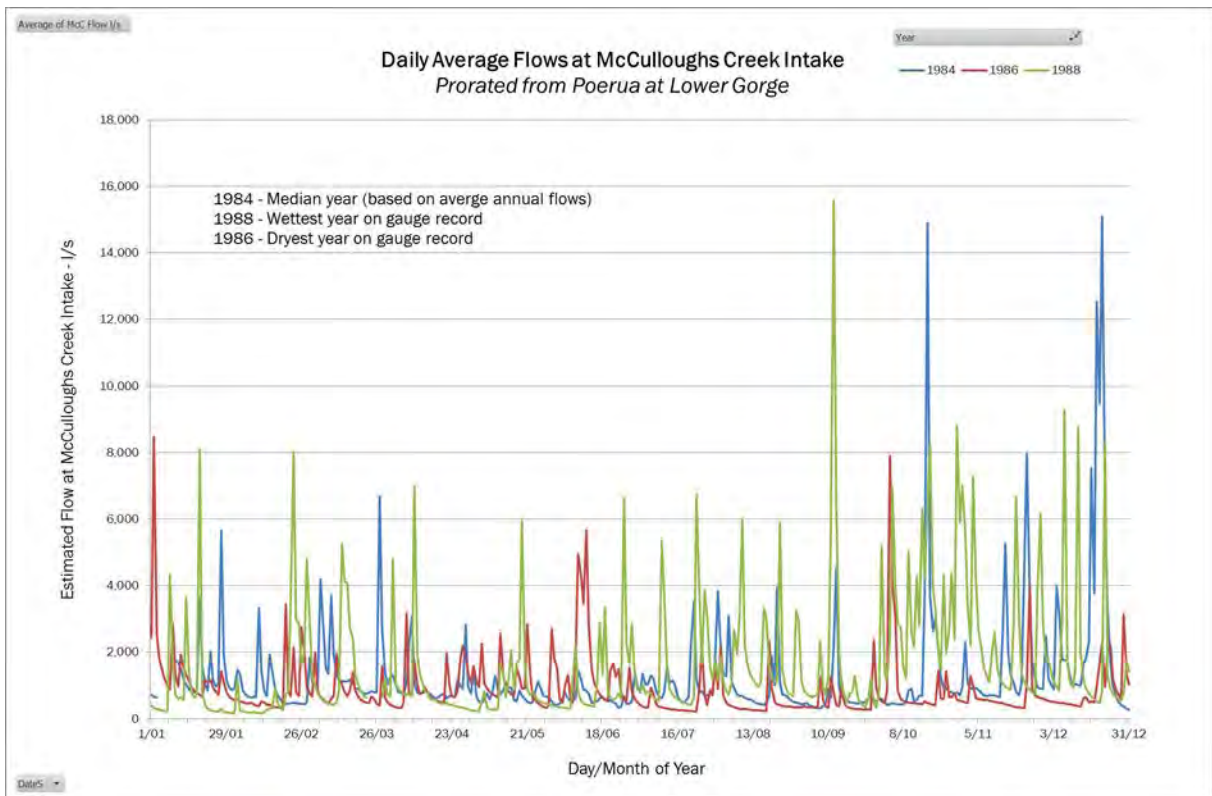

Figure 30 – Flow at McCulloughs Creek intake (prorated from Poerua at Lower Gorge)

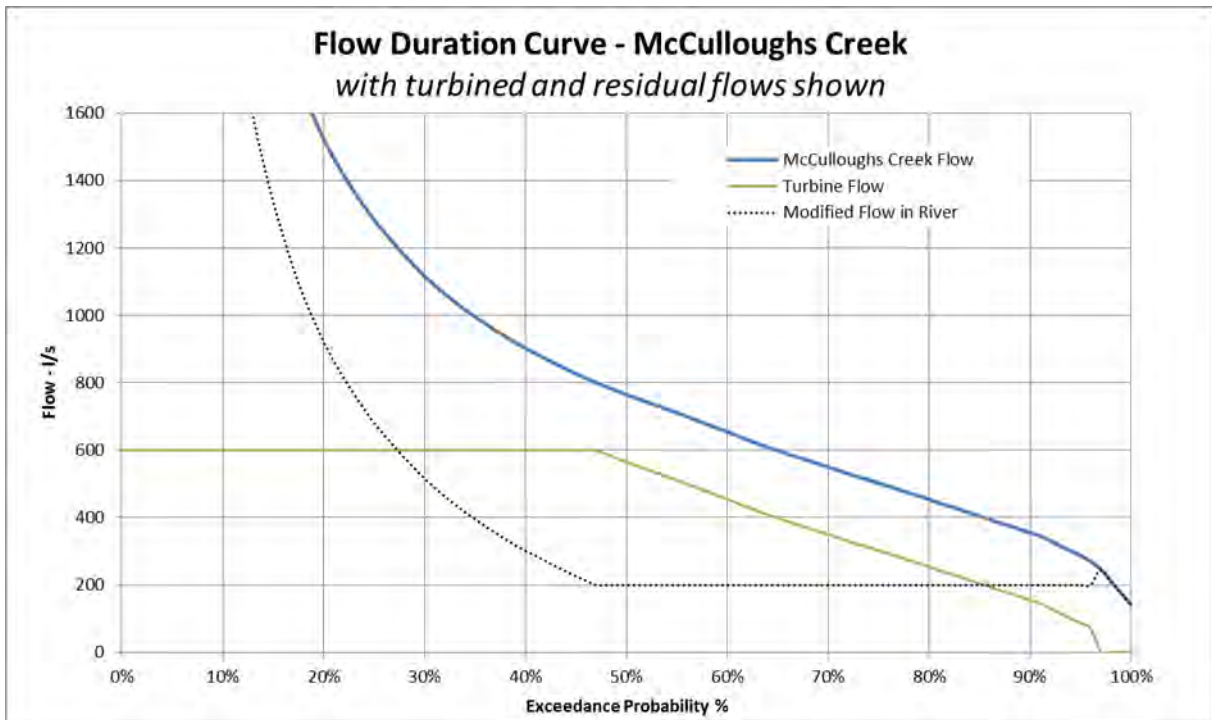

Figure 31 – Estimated flow duration curve at McCulloughs Creek intake

### 3.1.5 Low flows

The 7-day mean annual low flow (MALF) is regarded as a measure of the minimum amount of water that needs to remain in the stream to sustain the ecosystem specific to that river. Five separate methods were used to estimate the MALF in McCulloughs Creek, the average value was assumed for the purposes of this assessment. These five methods were as follows:

#### 3.1.5.1 C.P. Pearson Method.

This approach is based on the paper Pearson, C.P. 1995: “*Regional frequency analysis of low flows in New Zealand rivers*”. Journal of Hydrology (NZ). This paper investigates the annual minimum low flow series (1-day, 7-day and 30-day mean flows) from almost 500 catchments to identify regional patterns and frequency distributions of low flows within New Zealand. The study takes into account catchment characteristics (rainfall, elevation, etc.) to help explain regional variations. Low flows are categorised by similar regions to describe New Zealand annual low flow series. The MALF estimated using this method was **142 l/s**.

#### 3.1.5.2 Booker and Woods Method.

This approach is based on D.J. Booker, R.A. Woods. “*Comparing and combining physically-based and empirically-based approaches for estimating the hydrology of ungauged catchments*.” This paper provides predictions of hydrological regimes at ungauged sites with predictions reinforced using observed data from 485 gauging stations located across New Zealand. The paper provides means to estimate mean flow and 7-day mean annual low flow. The MALF estimated using this method was **237 l/s**.

#### 3.1.5.3 NIWA: Based on NIWA research map “*Mapping the Trickle*”<sup>14</sup>.

The method used a NIWA dataset for the 7-day MALF specific yield based on maps showing the average annual low flow for rivers and streams throughout New Zealand. The units of this dataset are l/s/km<sup>2</sup>, so to estimate the MALF, the values from the site location are taken from the dataset and multiplied by the catchment area. Figure 31 presents an image of this dataset with the project area illustrated. From this chart, the specific yield for the MALF is in the range of 50 to 100 l/s/km<sup>2</sup>. Roddy Henderson at NIWA advised that the value at this river reach is 64 l/s/km<sup>2</sup>. Multiplying by area of the catchment (4.49 km<sup>2</sup>) at the McCulloughs Creek intake location, the 7-day MALF was estimated to be **287 l/s**.

#### 3.1.5.4 Poerua Gauge

Calculation of the 7-day MALF based on proration of the Poerua Gauge, described in Section 3.1.4 above. Using the estimated flow data prorated from the Poerua River for the McCulloughs Creek intake for the period 1981 to 1993, the MALF was estimated to be **153 l/s**.

---

<sup>14</sup> <https://www.niwa.co.nz/freshwater-and-estuaries/freshwater-and-estuaries-update/no11-2005/mapping-the-trickle>

### 3.1.5.5 Instream gauging

The instream gauge has recorded approximately 6 months of data from 2 March 2017 to 24 August 2017 (175 days). Data from this series was prorated to the intake site as described in Section 3.1.3.2, where the MALF is estimated to be **330 l/s**, noting that the lowest flow months may be later in the year where freezing temperatures can reduce flows further. As a long time series (> 1 year) from the in-stream gauging is recorded this estimate will be updated.

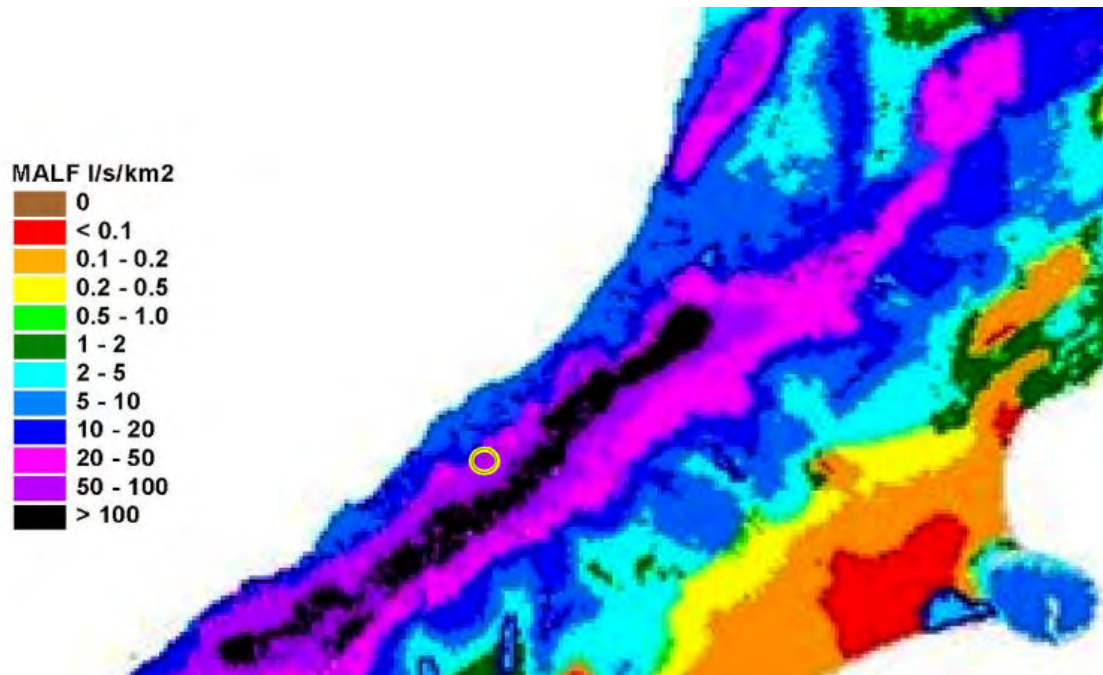

Figure 32 –MALF Specific Yield Map – NIWA

### 3.1.5.6 Summary of MALF estimates

A summary of the MALF estimates is presented in Table 7. At present, the estimates for MALF are based on published science, proration of nearby gauges and a limited hydrologic gauging dataset. Once the recorded dataset from the instream gauge is longer, actual flow measurements will take precedence and the MALF estimate revised to match the site.

For the McCulloughs Creek Hydropower Project, a conservative value of **250 l/s** is set as the environmental flow. This value will be updated as more data from site specific gauging is collected and the hydrology dataset is updated. For instream minimum flow requirements, 80% of MALF has been assumed, for a value of 200 l/s. This is consistent with the West Coast Regional Land and Water Plan, Rule 55 (ii):

#### *Rule 55 Take and use of surface water*

*Unless permitted by Rules 39, 40, or 42, or controlled by Rules 52 or 53, the taking and use of surface water where:*

- (i) The total volume of water allocated from the river is less than 20% of the mean annual low flow (MALF) of the river; or*
- (ii) The applicant accepts a minimum flow based on 75% of the mean annual low flow (MALF) of the river;*

Table 7 – Methods to estimate MALF

ID	Method	7-day MALF (l/s)
1	Regional frequency analysis of low flows in New Zealand Rivers - C P Pearson	142
2	Comparing and combining physically-based and empirically-based approaches for estimating the hydrology of ungauged catchments - D.J. Booker, R.A. Woods	237
3	Email correspondence with Roddy Henderson at NIWA	287
4	Poerua Gauge	153
5	McCulloughs Creek Gauge at Intake	330
<b>Average Value</b>		<b>231</b>

### 3.1.6 Floods

Flood magnitudes at the project site were estimated using the method proposed by C.P Pearson<sup>15</sup> (NIWA). The mean annual flood (MAF) was calculated to be 5.7 m<sup>3</sup>/s and the 100-year flood was estimated to be 15.2 m<sup>3</sup>/s. These are large floods for a small river, with the annual average flood approximately five times as large as the average flow (1,108 l/s).

Therefore, care will be taken to design structures (such as the intake) so that they can sustain high flows and velocities and resist large quantities of bedload. As discussed in Section 2.2.1, the intake is designed to pass the 100-year flood over the weir with no overtopping of abutments. Similarly, the powerhouse will be situated at an elevation sufficient to avoid flooding up to 100 year return period. Table 8 below outlines the flood magnitudes for a range of return periods, based on the C.P Pearson methodology.

Table 8 – Flood magnitude and return period

Return Period	Flood Magnitude (m <sup>3</sup> /s)
Mean Annual Flood (MAF)	5.7
5-year	7.6
10-year	9.5
20-year	11.3
50-year	13.6
100-year	15.2
1000-year	19.9

### 3.1.7 Hydrological Summary

The following table, Table 9 outlines key hydrologic parameters at the McCulloughs Creek intake site. These parameters form the basis of assumptions for the project site.

---

<sup>15</sup> C.P Pearson - Regional Flood Analysis for Small New Zealand Basins.  
<http://docs.niwa.co.nz/library/public/Regflood2.pdf>



Table 9 – Hydrology at intake site

Parameter	Value	Unit
Rainfall	4,900	mm/year
MALF (7-day)	250	l/s
Average annual discharge	1,108	l/s
Mean annual flood	5.7	m <sup>3</sup> /s
Design flood magnitude	15.0	m <sup>3</sup> /s
Design flood return period	1 : 100 year	

## 3.2 Geology

The geology of the area is distinctly different in the upper and lower reaches, due to the presence of the Alpine Fault. In the alpine reaches, the rock is basement (Eastern Province) metamorphic rock, consisting of prominently segregated schist, quartz-albite segregations, abundant pelitic schist and greenschist/metachert.

In the sub-alpine area, the geology is schist-derived mylonite, curly schist, cataclasite, in addition to greenschist/chert/pegmatite and fault breccia near the Alpine Fault. In the lower reaches, the geology consists of generally un-weathered, variable mixtures of gravel/sand/silt forming alluvial fans (surface slope 1 to 20 deg).

## 3.3 Ecology

No. 8 Limited engaged Wildland Consultants Limited (Wildlands) to undertake an Ecological Assessment at the McCulloughs Creek Hydropower Project location addressing vegetation, freshwater fish and macroinvertebrates. This section summarises the Wildlands Ecological Assessment report included in Appendix B of this report.

The McCulloughs Creek Hydropower Project is located within Central Westland (Te Wāhi Pounamu) and the Wilberg Ecological District, which is part of Whataroa Ecological Region. The Wilberg Ecological District includes the mountains inland from Harihari. These mountains comprise metamorphic rocks affected by the last glaciation. Soils in the Ecological Region consist of strongly-leached stony steep-land soils, grading into alpine soils at higher altitudes with large areas of scree and bare rock. At lower altitudes with easier slopes topsoils are peaty as a result of poor drainage. The Ecological District has a high rainfall mountain climate, with rainfall ranging from 5,000 to 8,000 mm per annum (Wildlands 2017).

### 3.3.1 Flora

The project area contains vegetation that is characteristic of the high rainfall and where beech forest is absent (Wildlands 2017). At low altitudes, slopes are covered by mixed podocarp-hardwood forest. At higher altitudes the forest cover is generally rātā-kāmahi forest, eventually becoming subalpine scrub zone and snow tussock grassland. According to McEwen 1987, the vegetation and flora of the District are relatively poorly known. The treeline in the area appears to be around 1,200 masl.

A feature of the vegetation in the region is the 'beech gap' where there is an absence of beech trees between the Taramakau and Pāringa Rivers, apart from a few outliers. This is likely due to past glacial activity, during the last ice age where the landscape was scraped clear of forest (Wildlands 2017).

According to the DOC CMS<sup>16</sup>, the forest is likely to be dominated by southern rātā, kāmahī, Quintinia/tāwheowheo and Hall's tōtara. This forest cover gives way to dense alpine scrub, grasslands, herbfields, bare rock and ice at higher altitudes. In the lower lying areas, the land has been cleared and is now generally grassland for agriculture, with dairy farming the primary activities.

The CMS outlines particular threats to the biodiversity of the region which include:

- Tradescantia fluminensis at the Ökārīto delta,
- buddleia in the Waiho River bed,
- crack willow around lakes, wetlands and rivers,
- gorse and broom in the Haast valley,
- giant gunnera in the Moeraki riverbed, and
- Didymo is present in the upper Haast River.

### 3.3.2 Observed and reported flora

According to Wildlands, vegetation in the project area consists almost entirely of indigenous forest. Five different forest types were identified onsite with areas of indigenous shrubland and grassland occurring near the riparian zone. From a human perspective, the vegetation appears unmodified however, there is evidence that it has been affected by feral goats and possums.

Vegetation near the intake site consists of indigenous riparian forest and scrub. Exposed rocks and boulders are covered in a variety of moss and lichen species. The proposed helicopter landing pad site contains indigenous grasses, sedges, herbs, ferns and other seedlings and shrubs. There is evidence in the area of animal browsing.

During the site visit on 16 May 2017, 92 indigenous vascular plant species and 10 non-vascular plant species (mosses, liverworts and lichens) were recorded in the project area, with no species classified as nationally Threatened or At Risk according to the New Zealand Threat Classification System. Three introduced plant species were seen during the field visit.

### 3.3.3 Fauna

According to McEwan 1987, there is a diverse avifauna in the region, but the densities are moderate due to uniform vegetation and introduced mammals. Introduced mammals present in the region include red deer, goats, possums, thar, chamois, rats and mice, with hedgehogs, stoats, weasels and ferrets also likely present.

---

<sup>16</sup> <http://www.doc.govt.nz/cms>

Other fishing and hunting guides<sup>17</sup> report that red deer, chamois and tahr exist in the Adams Wilderness Area and in the nearby catchments. There is evidence of feral goats living in the catchment with several sightings while on site in addition to evidence of browse.

Possums also exist in the catchment, however, DOC operations have kept the population to a low number<sup>18</sup>.

### 3.3.4 Observed and reported fauna

During the field visit on 16 May 2017 a number of indigenous bird species were observed, which included bellbird/korimako, kereru, South Island fantail/piwakawaka and the South Island tomtit/miromiro. None of these species are classified as Threatened or At Risk (Robertson et al. 2017), and are typical of indigenous forest habitat on the West Coast.

On other visits, observed native bird life included fantails (Piwakawaka) around McCulloughs Creek and weka observed on open farmland. Hawks were observed near SH6 and the lower reaches of the river, near farmland.

According to Wildlands, Feral goats (*Capra hircus*) appear to be common throughout the project area, as severe goat browse was seen on native broom (*Carmichaelia arborea*) and other palatable plant species at the upper survey site, faecal pellets were found at the intake site and along the pipeline/penstock route, and a feral goat was seen at the lower site during the field visit. Rooting by feral pigs (*Sus scrofa*) was observed along the lower section of the penstock route, particularly where canopy trees had been uprooted as a result of Cyclone Ita.

### 3.3.5 Freshwater fish and macroinvertebrates

A site visit was undertaken with Wildlands on 14 December 2016 to assess the freshwater macroinvertebrates in the downstream section of McCulloughs Creek. Observed macroinvertebrates were all indigenous and deemed typical of what would be expected in fast-flowing stony waterways in the forested parts of the South Island's West Coast. In general, Threatened and/or At Risk macroinvertebrate species are more likely to be found in seepages, headwaters and small tributary systems (Brian Patrick, Wildland Consultants, pers. comm.).

On a separate survey on 16 May 2017, electric fishing was carried out at the intake and powerhouse locations. This survey confirmed the presence of one indigenous fish species (kōaro) at the upstream site. Two indigenous fish species and one introduced fish species were found at the downstream site.

According to the Wildlands Ecological Assessment, mayflies and stoneflies were disturbed during electric fishing. Water temperature was measured as 5°C at the upstream site at 09:30 in the morning, and 8°C at the downstream site at 14:45 in the afternoon.

---

<sup>17</sup> <http://www.whataroa.org/whats-on-2/fishing-and-hunting/>

<sup>18</sup> <http://www.doc.govt.nz/parks-and-recreation/things-to-do/hunting/where-to-hunt/west-coast/franz-josef-hunting/where-to-hunt/whataroa/>

### 3.4 Archaeological & Historic Sites

A site investigation and desktop study were undertaken to identify any archaeological or historical sites in the area. However, no such sites were identified in the area using this method.

### 3.5 Existing Social Environment

Both the Waitangi Forest Conservation Area and the Whataroa Scenic Reserve are freely accessible to the public. Access by the public is one of the aspects that is protected under the Reserves Act 1977 and the Conservation Act 1987.

Currently, there is no access route in either the Waitangi Forest Conservation Area or the Whataroa Scenic Reserve. The access taken by the author and (anecdotally) the route taken by DOC and farmers in the area is following the river itself, using the forest when the river becomes impassable at waterfalls and gorges. Navigating the McCulloughs Creek valley is challenging and time consuming and takes around 8 to 10 hours return to get to the intake location and back.

Hunting is allowed in the area with red deer, chamois and tahr present.

Currently, the social environment consists of short-term visits by DOC, hunters, tourists, adventure seekers and others such as hydrologists and seismologists. There are no huts in the catchment or open areas that would be attractive for campers, currently.

A number of sources were reviewed for evidence of Maori history, settlements or areas of cultural significance. These were:

- Te Ara (Encyclopaedia of New Zealand),
- [www.Heritage.co.org.nz](http://www.Heritage.co.org.nz),
- [www.DOC.govt.nz](http://www.DOC.govt.nz)
- [www.nzarchaeology.org](http://www.nzarchaeology.org)

According to these sources, nothing suggests that this area is unique or significant from the point of view of Maori culture. In the CMS (Section 3.4.1.2 – Maori archaeological sites), it mentions, “no inland sites have been excavated or systematically studied and what is known tends to be from second hand information gathered from land owners and the finders of artefacts. Recorded locations of artefacts tend to be situated close to rivers and streams.” From what information is publically available, McCulloughs Creek and the surrounding area are not mentioned with regard to Tangata Whenua.

## 4 Effects of the Activity

This section describes the effects that the McCulloughs Creek Hydropower Project (*the Activity*) may have on the terrestrial, landscape, aquatic, marine, historic, cultural, and recreation values of the area. Any cumulative effects, effects on infrastructure or any other effects are outlined also. As described in Section 1.1, it is a primary objective of No.8 Limited to develop a low-impact hydropower scheme. Therefore, the scheme location has been identified based on the ability for it to avoid many of the issues common to water resource and hydropower schemes.

No.8 deems the effects on the Whataroa Scenic Reserve to be most sensitive, and with reference to the Reserves Act 1977, the following is a summary of how No.8 limited intends to mitigate the effects or improve these values in the Scenic Reserve, the Waitangi Forest Conservation Area and the Marginal Strip.

The general purpose of the Reserves Act 1977 is outlined below in five points with No.8's approach for maintaining these values outlined for each point:

- a) **to provide for the preservation and management of areas for the benefit and enjoyment of the public:**
  - *No.8 will install a publically accessible route, information and an elevated lookout to experience the scenic reserve and the views across the Whataroa plains. This track may continue approximately 2.0 km further into the valley to the intake site and provide access to the upper valley and river.*
- b) **to ensure, as far as possible, the survival of all indigenous species of flora and fauna:**
  - *The access track will assist DOC and other scientific and environmental groups to access the area to investigate, study, and ultimately ensure survival of indigenous species of flora and fauna.*
  - *During design and construction, No.8 will ensure the base-lining, ongoing monitoring and protection of all indigenous flora and fauna.*
- c) **to ensure, as far as possible, the preservation of access for the public:**
  - *The access track provided will increase and preserve the access to the public and others. Eventually, the area could have value as a Backcountry Remote Zone or Frontcountry site. This would have a beneficial effect to the general economy, especially around Whataroa itself.*
- d) **to provide for the preservation of representative samples of all classes of natural ecosystems and landscape:**
  - *The hydrological and climate data recording, in conjunction with other observations made from having the scheme in operation will be of benefit to science in general.*
  - *The access provided will allow parties not otherwise equipped for the task to access the area. This could include ecologists and other specialists to study the area and observe and study the natural ecosystems and landscape.*
- e) **to provide for the protection of the natural character of the coastal environment and the margins of lakes and rivers.**
  - *The flows selected for the scheme represent a small percentage of the stream flows, being approximately 55% of the annual average flow. There is no damming of the stream so floods and sediment will still occur in the natural state.*

Unlike other hydropower schemes, the McCulloughs Creek Hydropower Project does not result in:

- **the fragmentation of ecosystem:**
  - *apart from the fenced off powerhouse area, there are no barriers or impedances to ecosystems.*
- **loss of habitat or degradation of freshwater ecosystems:**
  - *There is no barrier to fish passage, no change to the hydrological regime where fish are present and no change to sediment load.*
- **invasive weed and animal pest infestation:**
  - *The scheme may result in a positive result with regard to the controls of animals and pests by virtue of improved access.*
  - *As part of project controls, a pest control and weed monitoring programme will be implemented and carried out by suitably qualified and experienced persons.*
- **adverse effects on wāhi tapu and other cultural values:**
  - *Currently there is little evidence of spiritually and culturally important aspects of the McCulloughs Creek catchment. This will continue to be investigated.*
- **alterations to the natural character of the landscape:**
  - *The components of the scheme will be small in footprint, be hidden by the natural topography and bush in the catchment to keep the sea-to-mountain view in as much of an untouched state as possible.*
- **control of public access:**
  - *There will be no control of public access to the area. In fact, the access route and lookout location proposed as part of the scheme will improve access to the area.*
- **changes to recreational opportunities and the type of public use of the area:**
  - *Apart from hunting and tramping, there is little other recreational use of the catchment. The proposed access route would allow members of the public to access and view the Scenic Reserve and the Whataroa Plains at the lookout.*

#### 4.1 Effects on freshwater ecosystem and mitigation measures

The aquatic values would be affected by the hydropower scheme area in the 2.8 km river reach between the intake location and the powerhouse, referred to as the *Affected River Reach*. Effects from changes in flows in the *Affected River Reach* and measures to mitigate these effects are outlined in Table 10 to Table 11 below.

During operation, the average flow rate in this section would reduce from the estimated 1,108 l/s to 860 l/s due to the development. This represents an average change of flow of 250 l/s at the intake location, or a 25% reduction in average flow, for the *Affected River Reach*. Water is returned to the river at the powerhouse, and hence, the downstream reaches maintain their natural state.

The amount of water extracted to operate the scheme is a small proportion of the flow rate of the river itself. The current design flow represents 54% of the average flow. As a reference point, larger utility scale projects often take 150% – 200% times the average flow. The minimum flow in the river in the *Affected River Reach* will be unchanged from the natural state. In addition, the floods and high

flow events will continue to flow over the intake, taking gravel and boulders downstream, with negligible change to the existing state of the river or the *Affected River Reach*.

The estimated frequency of affected flows is presented on Figure 30 and shown by the dotted series. This graph shows that there will always be at least the MALF in the *Affected River Reach*, with flows larger than the MALF occurring in this reach approximately than 50% of the time.

The powerhouse is to be located a significant elevation above the river to avoid flooding risk. The turbine does not need to be submerged under the tailwater level like a Francis turbine, so fish cannot enter the tailrace, turbine or machinery (illustrated in Figure 11).

The proposed mitigation measure to allow fish passage at the intake is to build an outlet in the weir for fish passage and install a Coanda screen. Fish are unable to enter a Coanda intake and an adjacent fish pass in the weir structure would allow fish to move up and downstream as necessary. The intake itself is sized for 30% more flow than that proposed for McCulloughs Creek Hydropower Project to account for potential blockages. However, the flow through the penstock would be limited to the design discharge of 600 l/s, so excess flow would overflow the intake and weir and continue downstream.

Hydropower schemes can affect sediment and nutrients loads and result in changes to dissolved oxygen and the temperature of the rivers they divert. Often this phenomenon is the result of the impounding of water by a large dam. In the case of the McCulloughs Creek Hydropower Project, there is no dam or impounded water and the presence of the rapids in the *Affected River Reach* means significant aeration is naturally generated. The water returning to the river from the powerhouse will be oxygenated in a similar fashion by virtue of using a Pelton wheel turbine in the powerhouse. The Pelton wheel is similar to a water wheel and is installed above the water level in the river. Jets of water are fired at buckets on a wheel, which spin the turbine. This process creates significant natural aeration of the water returning to the river.

As there is no impounding of water or damming of the stream, sediment and nutrients can continue downstream as they would in their natural state. Any sediment captured by the intake would be flushed back into the stream by the desander.

Mitigation measures during construction include:

- 1 An Erosion and Sediment Control Plan would be developed and implemented as part of the construction documentation.
- 2 Any rubbish and waste will be removed and disposed of in the appropriate manner. Any contaminants used during construction will be contained by sediment control traps and bunds. No machinery or equipment would be cleaned, stored or refuelled within 10 m of the creek and machinery will be well maintained to prevent leakage or spill. A response plan would be developed to containment or spill.
- 3 Works would be carried out to cause minimal disturbance to the waterway banks and substrate, with access/movement of vehicles or other machinery in the waterway kept to a minimum. Any damage/erosion that is attributable to the works is to be repaired.
- 4 Dewatering a section of riverbed is proposed during construction to allow placement of concrete formwork in the dry and limit the risk of contaminate discharge into the stream.

Sandbags are preferred because they can be filled using in-situ sand and gravel and are low impact. A small pump would be used to control seepage into the dewatered area as required. Any fish entering the dewatered area will be relocated to clear water, well away from the construction area.

- 5 The 17 m wide overflow intake weir is designed for a discharge of 600 l/s through a 2.4 wide Coanda screen and overflow over the weir itself. An additional outlet is provided to allow water to flow over the rock banks on the downstream face of the intake to allow fish to pass the weir up and downstream.
- 6 As far as is practicable, in-stream works will not be carried out during key fish spawning and migration periods. The weir will be constructed during low flow summer months outside of upstream and downstream fish spawning times - See Appendix 2 in Wildland Consultants report *Ecological Assessment for the Proposed McCulloughs Creek Hydropower Project, Whataroa, Westland*. The powerhouse site will be constructed out of the river itself and not require in-stream works.
- 7 All machinery and other equipment shall be cleaned before and after use at a site, using standard biosecurity protocols such as those developed by the Ministry of Primary Industries (Check, Clean, Dry) [www.biosecurity.govt.nz/cleaning](http://www.biosecurity.govt.nz/cleaning).

Mitigation measures during the operational phase include:

- 1 An Erosion and Sediment Control Plan is proposed as part of the O&M documentation.
- 2 Maintenance of the weir is likely to be infrequent and will be planned during low flow summer months outside of upstream and downstream fish spawning times.
- 3 The project, once in operation will use minor amounts of oil and grease in the turbine and generator, which will be prevented from entering the river or surrounding land by oil and grease traps. The project will use biodegradable lubricants such as Panolin wherever practicable.
- 4 No machinery or equipment would be cleaned, stored or refuelled within 10 metres of the Creek and will be maintained to prevent leakage or spill of oil or other chemicals.
- 5 Any sediment retained at the intake (<1.0 mm) will be flushed back to the river a short distance downstream. The desander is designed to remove sand particles down to 0.3 mm in diameter and allows sediment to be flushed periodically back to the natural stream to resemble normal conditions of duration, frequency, and volume.
- 6 The intake is a 2.4 wide Coanda screen with 1.0 mm bar spacing, so fish cannot be entrained during operation. An additional outlet is provided to allow water to flow over the rock banks on the downstream face of the intake to allow fish to pass the weir up and downstream.
- 7 The intake structure and associated elements are designed with the seven key principles of good practice for surface water intakes in mind. The seven key principles are intake location, approach velocity, sweep velocity, fish bypass design at screen, fish bypass design for connectivity, screening materials, and operations & maintenance.
- 8 The water intake structure will not take up the whole width of the Creek and an outlet is provided to allow water to flow over the rock banks on the downstream face of the intake to allow fish to pass the weir up and downstream even at low flow periods.



- 9 Natural fluctuations in water flow and discharge need to be able to occur and water abstraction should cease when the water level is at 80% mean annual low flow, consistent with the West Coast Regional Land and Water Plan.
- 10 As discussed in Section 2.2.5, the powerhouse and tailrace would be located a significant elevation above the river. This is done to avoid flooding risk and to ensure that the water can flow back un-impeded by tailwater into the river. Because the river and discharged water are not hydraulically connected, there is no risk of fish entering the tailrace or turbine workings. In addition, the tailrace would be formed concrete channel, discharging over placed riprap (reviewed by a suitably qualified person before being approved for construction). Therefore, there is no risk to erosion from the discharge of water back into the stream.
- 11 All machinery and other equipment will be cleaned before and after use at a site, using standard biosecurity protocols such as those developed by the Ministry of Primary Industries (Check, Clean, Dry) [www.biosecurity.govt.nz/cleaning](http://www.biosecurity.govt.nz/cleaning).
- 12 Data collected from the instream flow gauging will be used to facilitate accurate hydrological monitoring. This information will be used to assist with setting water abstraction limits and cessation triggers, and ongoing management of operations to minimise adverse effects on the freshwater ecosystem.
- 13 Baseline ecological monitoring would be undertaken before the proposed works are initiated, with seasonal fluctuations taken into account. This would include Freshwater ecosystem monitoring by suitably qualified and experienced people to determine whether the proposed activity is having ongoing adverse effects.

The following tables (Table 10 to Table 11) outline construction and operational effects and associated mitigation measures on freshwater ecology as described in the Wildlands Ecological Assessment. For further detail refer to Appendix B.

Table 10 - Identified construction effects on the freshwater ecosystem and mitigation measures

ID	Construction Effects	Mitigation Measure
FW1	Potential for sediment and/or other contaminants (e.g. fuels, oils, cement, hydraulic fluids) to enter the Creek, and directly and indirectly kill freshwater fish and invertebrates.	The instream construction area will be dewatered and protected with sandbag bunds to prevent contamination into the river. Machinery is limited and a small excavator is proposed if required. Cables and hand equipment will be used where practicable. No machinery or equipment shall be cleaned, stored or refuelled within 10 metres of the Creek. Machinery shall be well maintained at all times to prevent leakage or spill into the stream. A response plan will address containment of any spills.
FW2	Disturbance/damage of the substrate and banks can disrupt fish migration activities, crush freshwater plants and animals, including their eggs and larvae, and reduce habitat availability by destroying its structure and/or increasing sedimentation.	The intake weir location features mainly exposed bedrock. Therefore, there is minimal work in terms of excavation or removal of substrate at the intake site. Sediment load will not change as the bedload will be able to pass over the weir. Particles less than 1.0mm which may enter the intake will be able to be flushed a short distance downstream via the desander sluiceway.
FW3	Works carried out in flowing water can directly kill freshwater organisms, cause increased sedimentation, inhibit fish passage, trap fish, disrupt migration and spawning activities, and kill fish eggs and larvae.	The intake site features a side flood channel, which would be used to bypass the flow around the dewatered section using sandbags during construction. Sandbags are preferred because they can be filled using in-situ sand and gravel and are low impact. Dewatering a section of riverbed is proposed during construction to allow placement of concrete formwork in the dry and limit the risk of contaminate discharge into the stream. A small pump would be used to control seepage into the dewatered area as required. Any fish entering the dewatered area will be relocated to clear water, well away from the construction area.

ID	Construction Effects	Mitigation Measure
FW4	Machinery, and other equipment, brought into the construction site could inadvertently carry plant material (including seeds, and eggs from invertebrates and fish) from species not naturally occurring at the site, leading to future pest plant and pest animal issues.	Vehicles, equipment, and materials entering the site will be sourced carefully and inspected and cleaned thoroughly. All contractors working on site will be aware of the relevant biosecurity protocols.

*Table 11 - Identified operational effects on the freshwater ecosystem and mitigation measures*

ID	Operational effects	Mitigation Measure
FW5	Contaminants (e.g. fuels, oils, cement, sewage) entering the Creek can directly and indirectly kill freshwater organisms.	The project, once in operation will use minor amounts of oil and grease to lubricate rotating parts in the turbine and generator, which will be prevented from entering the river or surrounding land by oil and grease traps. The project will use biodegradable lubricants such as Panolin and greaseless bearings wherever practicable.
FW6	Sediment movement and deposition changes can affect aquatic organisms by causing structural habitat changes within the Creek.	Sediment load will not change as the bedload will be able to pass over the weir. Particles less than 1.0mm which may enter the intake will be able to be flushed a short distance downstream via the desander sluiceway. The desander is designed to remove sand particles down to 0.3 mm in diameter and allows sediment to be flushed periodically back to the natural stream. Therefore, there will not be a change in sediment loads, duration or frequency in the affected reach.

ID	Operational effects	Mitigation Measure
FW7	Upstream and downstream fish passage could be blocked or inhibited by structures built in the Creek. The species recorded in McCulloughs Creek must travel between the marine and freshwater environments to compete their lifecycle. Blockage or inhibition of fish passage could have significant adverse effects, and would contravene the Freshwater Fisheries Regulations 1983.	The 17 m wide overflow intake weir is designed for a discharge of 600 l/s through a 2.4 wide Coanda screen. The Coanda screen has 1.0 mm screen spacing, so fish entrainment is unlikely to occur and the technology is typically referred to as fish friendly. For example NIWA guidelines for fish screening recommend the use of Coanda screens. An additional outlet is provided to allow water to flow over the rock banks constructed on the downstream face of the weir (away from the intake structure) will allow fish to pass the weir, both up and downstream during low flows.
FW8	The water intake structure/s could directly injure or kill fish if they get drawn into the mechanism.	Coanda screens are self-cleaning and have the ability to exclude very fine debris, fish and small aquatic organisms. These screens have been used frequently and operation regarding fish passage and exclusion has been successful.
FW9	Removal of water from the Creek will increase the number of low flow days per year, when the Creek is at the mean annual low flow level (MALF) along the three kilometre reach between the intake site and powerhouse outlet, reducing habitat availability for freshwater organisms. It could also cause: loss of connectivity between upstream and downstream areas, changes in availability of food and nutrients, water quality changes, structural habitat changes through altered movement of sediments and other material, changes in the water flow regime, fish and invertebrate community changes, reduced respiration and egg aeration, altered fish migration triggers, and increased algal growth.	The flow through the intake will be monitored using flow gauges at the intake site and through the turbine at the powerhouse. This metering will ensure that the system is always leaving the minimum flow in McCulloughs Creek and allow recording for consent requirements. The flow will be returned to the river at the powerhouse where the river becomes gentle and a larger more diverse fish population is living. This part of the river will therefore see no change in water flow, turbidity or sediment load.  The baseline ecological report will identify changes to the ecology in the <i>Affected River Reach</i> .

ID	Operational effects	Mitigation Measure
FW10	Discharge of water from the tailrace, desander, and any other spillways could cause erosion of the waterway and/or its banks, altering habitat, and could attract fish to enter the pipes.	Any bank erosion would be detrimental to the powerhouse structure built on top and hence, the area chosen for the powerhouse is an area where bank erosion cannot occur. In addition, the outlet (tailrace) would be made of precast concrete channel and would flow over a drop into the river. This is discussed in Section 4.3.2.1. The tailwater is not connected to the turbine (Section 2.2.4) therefore, fish are not able to enter the powerhouse or turbine area.
FW11	Machinery and other equipment brought in for maintenance works could inadvertently carry plant material (including seeds, and eggs from invertebrates and fish) from species not naturally occurring at the site, leading to future pest plant and pest animal issues.	Vehicles, equipment, and materials entering the site will be sourced carefully and inspected and cleaned thoroughly. All contractors working on site will be aware of the relevant biosecurity protocols.

## 4.2 Effects on vegetation

The most significant effect to the land from the project is related to the clearing of native vegetation and any visual effects arising from the activity. In order to develop a low-impact scheme and reduce the vegetation clearance effects, No.8 Limited would utilise a temporary aerial cableway and helicopter to construct the scheme and a foot access route would be used for permanent access. The temporary cableway would be constructed under the forest canopy as much as is practicable. This route would be able to be made much steeper than a vehicle road, much shorter and with significantly less impact. This methodology would allow the construction of scheme components without constructing roads for vehicular traffic.

The cableway will be constructed directly above the penstock alignment to allow the transport of materials and pipe to where they need to be installed. The cableway will be installed through the vegetation without removal of the canopy trees larger than 30 cm dbh. (diameter at breast height). Once the construction of the penstock, intake and desander are completed, the cableway would be removed and low level bush allowed to regenerate in areas not used by the scheme. This track would resemble a typical hiking route in New Zealand bush.

Once operational, the pedestrian access route next to the pipeline would be around 1.0 to 0.75 m wide. The track would serve as access for the construction staff and allow operation and maintenance of the intake and penstock on foot.

### Mitigation measures during construction include:

- 1 Destruction and disturbance to indigenous vegetation during construction of the access road, pipeline/penstock, powerhouse and helicopter landing pad would be reduced by keeping the construction footprint as small as possible. Large canopy trees (30 cm dbh) would be avoided as much as possible to reduce 'edge effects' on adjacent forest and the potential for wind-throw.
- 2 The amount of gravel and artificial building materials (concrete, steel, timber, plastic etc.) brought in for construction of the proposed structures would be limited. Existing river gravels in McCulloughs Creek would be utilised for construction of the intake and helicopter landing pad. River gravel, boulders and sand would be utilised in the concrete mix, with larger boulders used for placement on the downstream faces of the weir. Sandbags to be used for dewatering because they can be filled using in-situ sand and gravel and are low impact.
- 3 Vehicles, equipment, and materials entering the site will be sourced carefully and inspected and cleaned thoroughly. All contractors working on site will be made aware of the relevant biosecurity protocols.
- 4 Contractors working on site would be made aware of the relevant biosecurity protocols.
- 5 Monitoring for introduced weeds will be carried out during construction by suitably qualified and experienced persons. The key sites for weed monitoring are the intake site, powerhouse, pipeline/penstock corridor, and access road.
- 6 Control of weeds would be implemented in a timely manner by a suitably trained person using the most appropriate methods.

Mitigation measures during construction include:

- 1 Removal of vegetation in the Whataroa Scenic Reserve would be intentionally limited and areas of bush removed but not required for permanent access will be allowed to regenerate post construction. Large canopy trees (30 cm dbh) would be avoided as much as possible to reduce 'edge effects' on adjacent forest and the potential for wind-throw.
- 2 Monitoring for introduced weeds will be carried out during operation by a suitably qualified and experienced person. Control of weeds will be implemented in a timely manner by a suitably trained person using the most appropriate methods.
- 3 Control of pest mammals (particularly feral goats) in the project area would be implemented to help mitigate residual adverse effects on indigenous vegetation. A pest control programme will be developed in consultation with suitably qualified professionals and the Department of Conservation.
- 4 Helicopter landing areas will be left to regenerate from local seed sources

Table 12 and Table 13 outline construction and operational effects and associated mitigation measures to reduce the effect on vegetation as described in the Wildlands Ecological Assessment. For further detail refer to Appendix B.

Table 12 - Identified construction effects on vegetation and mitigation measures

ID	Construction Effects	Mitigation Measure
V1	Construction of the helicopter landing pad would result in destruction of and/or disturbance to approximately 220 m <sup>2</sup> of indigenous vegetation.	Helicopter landing areas will be removed and the areas left to regenerate from local seed sources.
V2	Construction of the water intake would cause damage to indigenous riparian vegetation adjacent to the waterway, however this would activity would affect a relatively small area	Once construction is completed, these areas will be allowed to naturally regenerate.
V3	Construction of the cableway, pipeline (including the desander) and penstock would result in the destruction of approximately 2,935 m <sup>2</sup> of indigenous forest along the proposed corridor. As well as the direct loss of vegetation within the corridor, this would result in fragmentation of the forest along the corridor, leading to “edge effects”.	One of the principles of the development is to avoid large removal of native bush, as described in Section 2.1.4 - Avoiding Removal of Large Areas of Bush. Where possible, the clearing of bush would be limited to small plants and saplings. Removal of vegetation in the corridor would be intentionally limited. Areas of bush removed for construction but not required for permanent access will be allowed to regenerate post construction. Large canopy trees (e.g. 30 cm dbh) will be avoided as much as possible, in order to reduce ‘edge effects’ and the potential for wind-throw.
V4	Opening up gaps in the forest canopy would also make the adjacent forest more vulnerable to wind-throw in storm events, thus increasing the total area of forest that is disturbed.	As above.
V5	Discharge of water and gravel from the pipeline desander would be expected to cause minor disturbance to indigenous vegetation.	Water will be discharged down natural water channels as shown on drawings in Appendix A.
V6	Construction of the powerhouse and access road would result in the destruction of 652 m <sup>2</sup> of vegetation in Whataroa Scenic Reserve and 1,082 m <sup>2</sup> of vegetation in the McCulloughs Creek Marginal Strip (1,733 m <sup>2</sup> in total).	Where possible, the clearing of bush would be limited to small plants and saplings. Removal of vegetation in the corridor would be intentionally limited and areas of bush removed but not required for permanent access will be allowed to regenerate post construction.



ID	Construction Effects	Mitigation Measure
V7	The Marginal Strip contains both indigenous forest and modified pasture grassland; clearance of a relatively small area of indigenous forest in the Marginal Strip would have a minor adverse effect on indigenous vegetation.	Where possible, the clearing of bush would be limited to small plants and saplings. Removal of vegetation in the corridor would be intentionally limited. Areas of bush removed for construction but not required for permanent access will be allowed to regenerate post construction. Large canopy trees (e.g. 30 cm dbh) will be avoided as much as possible.
V8	Introduced weeds could be introduced to the project area through access by people, vehicles, equipment and construction materials (particularly stones and gravels) carrying weed propagules (seeds and/or fragments).	Vehicles, equipment, and materials entering the site will be sourced carefully and inspected and cleaned thoroughly. All contractors working on site are aware of the relevant biosecurity protocols.
V9	Access by introduced pest mammals such as feral goats and pigs could be facilitated by clearance of vegetation along the pipeline/penstock corridor, as pest animals will often utilise such tracks for movement.	A pest control programme will be developed during construction and operation.

Table 13 - Identified operational effects on vegetation and mitigation measures

ID	Operational effects	Mitigation Measure
V10	Maintenance of the pipeline, penstock, and foot access track would require ongoing clearance of indigenous plants that regenerate along the corridor.	The clearing of bush along the corridor post construction would be limited to small plants and saplings.
V11	Operation of the desander would involve sediment-laden water being discharged back into the Creek via a small watercourse in the forest.	Water will be discharged down natural water channels as shown on drawings in Appendix A.
V12	It is intended that the helicopter landing pad would be removed after the intake structure has been installed. Indigenous vegetation would be expected to naturally re-colonise the disturbed area over time, as there is an ample seed source of suitable plant species surrounding the site.	Helicopter landing areas will be removed and the areas left to regenerate from local seed sources.

### 4.3 Summary of Mitigation measures for freshwater ecology and vegetation

1. The scheme being proposed by No. 8 Limited aims to use as little water and as much head as possible to generate power. This is to ensure that the natural state of the river is modified as little as possible,
2. The water intake structure will not take up the whole width of the Creek and an outlet is provided to allow water to flow over the rock banks on the downstream face of the intake to allow fish to pass the weir up and downstream even at low flow periods.
3. Natural fluctuations in water flow and discharge need to be able to occur and water abstraction should cease when the water level is at 80% mean annual low flow, consistent with the West Coast Regional Land and Water Plan.
4. Data collected from the instream flow gauging will be used to facilitate accurate hydrological monitoring. This information will be used to assist with setting water abstraction limits and cessation triggers, and ongoing management of operations to minimise adverse effects on the freshwater ecosystem.
5. Baseline ecological monitoring would be undertaken before the proposed works are initiated, with seasonal fluctuations taken into account. This would include Freshwater ecosystem monitoring by suitably qualified and experienced people to determine whether the proposed activity is having ongoing adverse effects.
6. No.8 proposes to use a corridor approach in the application because it allows a low impact approach to the design where natural features, flora and fauna can be avoided,
7. One of the principles of the development is to avoid large removal of native bush, as described in Section 2.1.4 - Avoiding Removal of Large Areas of Bush. Where possible, the clearing of bush would be limited to small plants and saplings less than 30 cm dbh and the infrastructure installed under the natural canopy. Removal of vegetation in the Whataroa Scenic Reserve would be intentionally limited and areas of bush removed but not required for permanent access will be allowed to regenerate post construction,
8. As mentioned in Section 2.1, the HDPE penstock would be constructed above ground and would be able to weave in and out of the trees. This would create a penstock alignment which avoided significant flora, habitat and areas of instability and streams,
9. The project is protected from bank erosion and flooding risk by engineering design and use of a Pelton turbine in the powerhouse, and
10. Any contaminants used during the construction process would be carefully contained and removed. For example, sediment traps would contain runoff from areas where concrete, oil, grease and adhesives are used. Environmentally friendly grease such as Panolin used, wherever practicable.

## 4.4 Effects on terrestrial and landscape values

As noted in Section 3, the *Activity* is spread across three DOC administrative areas: the marginal strip alongside lower McCulloughs Creek, the Whataroa Scenic Reserve and the Waitangi Forest Conservation Area.

The most significant effect to the land from the *Activity* is related to the clearing of native vegetation and any visual effects arising from the activity. The scheme component with largest potential for effects on the visual and landscape values of the Scenic Reserve is the steep, GRP/Steel penstock alignment. The proposed activity aims to reduce the removal of native bush in this area to a minimum, with the pipe itself installed under the forest canopy where possible, meaning that it will not be visible from a far.

The construction methodology involves the use of a cableway and remote, helicopter construction techniques for the intake and desander. This aspect is to avoid the need for construction vehicles travelling the length of the site.

In order to facilitate the construction of the various scheme components, there will be some clearance of native vegetation, however limited where possible to vegetation with a diameter at breast height of less than 30 cm. Specifically, these areas are the:

- powerhouse access and distribution line route,
- powerhouse,
- construction laydown areas,
- intake and desander locations,
- along the penstock alignment, and
- the proposed public lookout.

The project principles described in Section 1.1 mean that any modifications to the bush will be minimised. The scale of the infrastructure is small and will be located in areas, which are hidden from public view by the topography itself, and the bush cover.

It is unlikely that the access track and penstock would be visible from the surrounding areas as it will be of small footprint and covered by native bush. Any areas of vegetation removed but not required for permanent access will be allowed to regenerate. Sediment Management Plans will be in place during construction to ensure that any contaminants used during the construction process would be carefully contained and removed.

### 4.4.1 Waste and contamination

Any rubbish and waste will be removed and disposed of in the appropriate manner. Any contaminants used during construction will be contained by sediment control traps and similar. The project, once in operation will use minor amounts of oil and grease to lubricate rotating parts in the turbine and generator. These lubricants would be prevented from entering the river or surrounding land by oil/grease traps. The project will use biodegradable lubricants such as Panolin<sup>19</sup> wherever practicable.

---

<sup>19</sup> [http://www.panolin.com/inten/products\\_new/\\_hydropower/hydropower\\_overview.php](http://www.panolin.com/inten/products_new/_hydropower/hydropower_overview.php)

## 4.5 Recreation, enjoyment and free access

As mentioned, there is currently no access route in the Waitangi Forest Conservation Area or the Whataroa Scenic Reserve. The project site is accessible by the river itself during periods of low flow, or by using the forest.

The current recreational value, enjoyment or free access of the site is limited by the remoteness and lack of permanent access. No.8 Limited proposes to improve access to the general area by the construction of the penstock access track and the lookout point at the summit.

The walk would climb approximately 400 m in elevation with spectacular views to the west, across the Whataroa farmland. There would be a further 1.7 km of track traversing the valley to the proposed intake location. This track would provide the public the ability to access the native bush and the river. For DOC, this would allow easier access into the area, for conservation activities.

The proposed track would be similar to that at Pioneer Generation's Wye Creek<sup>20</sup> hydropower scheme, where there is a public access track, alongside the penstock, so that the public, hunters and DOC can gain access to the area.

### 4.5.1 Noise

Hydropower schemes are generally considered quiet, with only an audible "hum" when standing beside the powerhouse. The rapids near the powerhouse site are loud and the roar of the water would likely drown out noise from the powerhouse. On the site visit for example, two people standing near the powerhouse area had difficulty hearing each other even with below average flows in the creek. Therefore, the effect of noise made by the hydropower scheme is anticipated to be minor.

### 4.5.2 Public Safety

Public safety and the schemes compliance with the NZ Health and Safety Act 2015 is of utmost importance. In order to ensure that the public are kept away from sensitive equipment or dangerous areas, appropriate signage and fencing will be installed. In addition to these fences and signs, warning signs and other information such as maps will be installed to inform members of the public of the scheme and the associated risks.

Ramping rates of the turbine unit would be set with consideration for the downstream effects from rapid changes to flow.

### 4.5.3 Mitigation measures

1. No.8 Limited proposes to improve access to the general area by the construction of the penstock access track and the lookout point at the summit. The track would provide the public and DOC the ability to access the native bush and the river,
2. Install appropriate signage and fencing,

---

<sup>20</sup> <http://www.doc.govt.nz/parks-and-recreation/places-to-go/otago/places/remarkables-conservation-area/things-to-do/lower-wye-creek-track/>

3. Install warning signs and other information such as maps to inform members of the public of the scheme and the associated risks, and
4. Ramping rates of the turbine unit would be set with consideration for the downstream effects from rapid changes to flow rates.

#### 4.6 Visual effects

The tallest scheme components are the cableway lattice steel supports at 5.0 m to 10.0 m tall and for this reason, are the most likely to be seen. The forest is (on average) 5.0 m to 10.0 m tall and the canopy trees will be avoided, so the natural vegetation will likely obscure the cableway supports and small clearing. The design area for the lower cableway support and laydown area has been reduced significantly in size since site visits and discussions with contractors. The original design had estimated a clearing of 750 m<sup>2</sup>, which was an area 25 m by 30 m. The revised design for the lower cableway support and laydown area is 100 m<sup>2</sup> (10.0 m by 10.0 m). This revised design is to further reduce the effects of clearing in the native forest. The design area for the upper cableway support and laydown area is 50 m<sup>2</sup> (10.0 m by 5.0 m). In both clearings the large canopy trees will be avoided.

The cableway will be installed to traverse a distance between elevations 175 m to 375 m (above sea level), so the natural altitude will also obscure the view of the cableway and penstock corridor, when viewed from the lower plains or highway. The highway and surrounding farmland is at an elevation of 60 m to 80 m.

Site access and the point of interconnection for the project is planned to be at the main highway. Here, the access road and distribution line would be installed from the highway along the marginal strip. The land in this area is already cleared for farming and therefore, the additional visual impact would be negligible.

Where the access and distribution line continue into the Whataroa Scenic Reserve, the view is obscured by the natural forest and ridgelines. In this area No.8 intends to bury the distribution line in a conduit to reduce the visual effects of a line installed on above-ground poles, acknowledging this land is scenic reserve. The distribution line would eventually return to poles in the marginal strip to interface with the Westpower Network.

Overall, the visual effects of the scheme are deemed to be minor during construction and negligible after construction, once regeneration has taken place.

Figure 32 shows a view from the southern side of the McCulloughs Creek Bridge showing both the density of the forest cover and indicative locations of the powerhouse and access road along the marginal strip. The purpose of this figure is to illustrate that the scheme will be generally obscured from view at most angles.



Figure 33 – View from south side of McCulloughs Creek Bridge on Highway 6 showing view obscured by forest cover.

#### 4.6.1 Viewshed Analysis

This section discusses the viewshed analysis for McCulloughs Creek Hydropower Scheme to help understand which areas may be visible to an observer. As Highway 6 is an area accessible to the public with a prominent view of the McCulloughs Creek environs, it has been assumed that an observer would be located there. This area represents the observation point with the potential for the greatest visual effect.

For the McCulloughs Creek Hydropower Scheme viewshed analysis, the observer is located on the north side of the bridge, as illustrated by the yellow circle on Figure 34. The blue areas show the parts of the surface model that are able to be seen from the observer location.

The model does not account for the forest, natural canopy, or atmospheric condition, so what is seen by an observer at that location is expected to reflect the worst case.

Figure 34 shows that the areas with the highest potential for visual effects are the lower penstock alignment and the lower cableway support and laydown areas, however these areas will be under canopy cover. It is unlikely that the access route will be visible due to the forest cover – See the image in Figure 32 showing a view from the southern side of the McCulloughs Creek Bridge.



Figure 34 – Viewshed Analysis

#### 4.6.2 Access tracks in native West Coast rainforest for comparison

The following section outlines some examples of similar dimensioned tracks in West Coast forest for purposes of comparison with the McCulloughs Creek Hydropower Scheme. The tracks described herein are:

- Lake Wombat Track at Franz Josef, and
- Callery Gorge Walk at Franz Josef.

##### Lake Wombat Track at Franz Josef

Figure 34 shows an example of the Lake Wombat track near Franz Josef<sup>21</sup>. Figure 35 presents a detailed aerial photo of the same track with and without the location of the track shown. The purpose of the image is to illustrate that the penstock alignment is unlikely to be visible from the surrounding area, once regenerated.

This track has similar dimensions and forest cover to the corridor planned for the McCulloughs Creek project, and hence is useful as a reference.

---

<sup>21</sup> <http://www.doc.govt.nz/parks-and-recreation/places-to-go/west-coast/places/westland-tai-poutini-national-park/things-to-do/tracks/lake-wombat-track/>



Figure 35 - Lake Wombat Track



Figure 36 - Lake Wombat Track showing the track obscured by native forest canopy - Franz Josef

### Callery Gorge Walk at Franz Josef

Figure 36 shows an example of the Callery Gorge Walk, also near Franz Josef<sup>22</sup>. Figure 36 presents an image from Google Streetview<sup>23</sup> viewed towards the location of the track. The purpose of the image is to show that a track or clearing in this type of forest is significantly obscured by natural canopy. As

---

<sup>22</sup> <http://www.doc.govt.nz/parks-and-recreation/places-to-go/west-coast/places/westland-tai-poutini-national-park/things-to-do/tracks/lake-wombat-track/>

<sup>23</sup> Google Streetview



above, the track has similar dimensions and forest cover to the corridor planned for the McCulloughs Creek project.



Figure 37 - Callery Gorge Walk showing the track obscured by native forest canopy - Franz Josef<sup>24</sup>



Figure 38 – Callery Gorge Walk showing the track obscured by native forest canopy - Franz Josef<sup>25</sup>

---

<sup>24</sup> <http://www.panoramio.com/photo/29588856?source=wapi&referrer=kh.google.com>

<sup>25</sup> Google Streetview

### 4.6.3 Mitigation measures to mitigate visual impacts

Since the site visit and inspection along the penstock alignment, a decision was made to alter the design to reduce the visual effects from the construction of the project.

The four significant changes made to the design are:

1. Destruction and disturbance to indigenous vegetation during construction of the access road, pipeline/penstock, powerhouse and helicopter landing pad would be reduced by keeping the construction footprint as small as possible. Large canopy trees (30 cm dbh) would be avoided as much as possible to reduce visual effects (and effects to indigenous vegetation – Section 4.2).
2. Realignment of the upper part of the penstock so that it will avoid steep, challenging terrain and result in a slightly shorter route. The penstock was initially designed at near-flat grade, to reduce the pressure in this section of pipe. The revised design uses a 10% grade to bring the pipe lower down the slope, where the terrain is more forgiving. This design will require a thicker walled class of HDPE pipe in the lower sections. This realignment reduces the total penstock length by approximately 300 meters.
3. Reduction in the length of the cableway to reduce visual effects and complexity. The upper cableway support and laydown area has been moved down from elevation 520 masl to approximately 375 to 400 masl, or approximately 150 m lower in elevation. This results in the length of the cableway being reduced by 300 m (from 750 m long to 450 m).
4. Reduced dimensions of the lower cableway support and laydown area from 750 m<sup>2</sup> to 100 m<sup>2</sup>.
5. Addition of intermediate cableway supports to allow for a smaller corridor to reduce the height of the hanging cable to approximately natural canopy height. The choice to use intermediate supports was based on conversations with forestry cable-yarding contractors who provided useful information to refine the design assumptions. The advantage this has had for the scheme is that tighter clearances are possible and the cableway itself can negotiate changes in grade and alignment.

It should be noted that this alignment is indicative and will be revised further once detailed topographical survey has been acquired. No.8 Limited still intends to use the corridor approach as in the applications to ensure that these iterations can be made as required.

### 4.7 Effects on Historic values

There is likely minimal effect on historic values, as the area does not have any archaeological or historical sites identified. See Section 3.4.

#### **4.7.1 Mitigation measures**

During detailed design, an investigation will be undertaken using both on-site techniques and literature research. Any finds will be reported to DOC and studied further.

### **4.8 Effects on Cultural values**

No information currently exists regarding the cultural and social history of McCulloughs Creek, however, it does not mean that there has been no history there. During site investigations, the area would be checked for items of historical and cultural significance and the scheme and effects would be discussed with the groups in the area. It is envisaged that there would be no offensive aspects of the scheme to Tangata Whenua or members of the public generally.

#### **4.8.1 Mitigation measures**

As above, during detailed design an investigation will be undertaken using both on-site techniques and literature research. Any finds will be reported to DOC and studied further.

### **4.9 Infrastructure Effects**

The effects on the local infrastructure will be minor. During construction, there will be a likely maximum of five small additional vehicles using the roads per day. There will be a grid connection to the Westpower network. The effect to the distribution infrastructure will be determined by the connection study. In many cases, the effect to the system can be positive due to a strengthened electrical grid and avoided costs for transmission.

#### **4.9.1 Mitigation measures**

1. Discuss extensively with local authorities, and
2. Engage with community to discuss potential disruptions and solutions.

### **4.10 Cumulative Effects**

There will be no cumulative impact on the area from the installation of the scheme because it will be the only development currently in the catchment.

## 5 Statutory Provisions

### 5.1 Concession Applications and the Conservation Act 1987

The consideration and granting of an application for concession by the Minister is undertaken pursuant to “Part 3B Concessions” of the Conservation Act 1987 (Act).

The information to be supplied in an application for concession is set out in section 17S Act. That section is reproduced below, together with where in this EIA the relevant information can be found.

#### **17S Contents of application**

(1) Every application for a concession shall include the following information:

(a) a description of the proposed activity:

*Refer section 2, in particular.*

(b) a description identifying the places where the proposed activity will be carried out and indicating the status of such places:

*Refer section 2, in particular.*

(c) a description of the potential effects of the proposed activity, and any actions which the applicant proposes to take to avoid, remedy, or mitigate any adverse effects:

*Refer section 4, in particular, including the mitigation measures proposed; note also the description of the environment in section 3.*

(d) details of the proposed type of concession for which the applicant is applying:

*3a Use of public conservation land for private/commercial facility/structure*

*3b Easements across public conservation land including right of way, stock access, convey electricity, drain sewerage, waterpipes etc*

(e) a statement of the proposed duration of the concession and the reasons for the proposed duration:

*40 years to align with the Resource Consent.*

(f) relevant information relating to the applicant, including any information relevant to the applicant’s ability to carry out the proposed activity.

*Refer this EIA generally, including section 1, which sets out the applicant’s approach and philosophy.*

(2) Where an applicant applies for—

(a) a lease; or

(b) a profit à prendre or a licence granting an interest in land; or

(c) an easement; —

the applicant, in addition to supplying the information required by subsection (1), shall supply reasons for the request and sufficient information to satisfy the Minister, in terms of section 17U, that it is both appropriate to grant the lease, profit à prendre, licence, or easement and lawful to grant it.

*Refer section below.*

Section 17U provides:

**17U Matters to be considered by Minister**

- (1) In considering any application for a concession, the Minister shall have regard to the following matters:
  - (a) the nature of the activity and the type of structure or facility (if any) proposed to be constructed:
  - (b) the effects of the activity, structure, or facility:
  - (c) any measures that can reasonably and practicably be undertaken to avoid, remedy, or mitigate any adverse effects of the activity:
  - (d) any information received by the Minister under section 17S or section 17T:
  - (e) any relevant environmental impact assessment, including any audit or review:
  - (f) any relevant oral or written submissions received as a result of any relevant public notice issued under section 49:
  - (g) any relevant information which may be withheld from any person in accordance with the Official Information Act 1982 or the Privacy Act 1993.
- (2) The Minister may decline any application if the Minister considers that—
  - (a) the information available is insufficient or inadequate to enable him or her to assess the effects (including the effects of any proposed methods to avoid, remedy, or mitigate the adverse effects) of any activity, structure, or facility; or
  - (b) there are no adequate methods or no reasonable methods for remedying, avoiding, or mitigating the adverse effects of the activity, structure, or facility.

The information contained in the application is adequate and sufficient for the purpose of assessing environmental effects of the Activity. A comprehensive assessment of potential adverse effects has been undertaken as part of planning for the location and design of the Activity. Where possible features of the Scheme have been designed to avoid or mitigate potential effects. The application also suggests a range of mitigation measures to avoid and minimise potential effects.

Section 17T of the Act sets out the process for every complete application received by the Minister. At Section 17T(2) the Act states:

- (2) If the Minister is satisfied that the complete application does not comply with or is inconsistent with the provision of this Act or any relevant conservation management

strategy or conservation management plan, he or she shall, within 20 working days after receipt of the application, decline the application and inform the applicant that he or she has declined the application and the reasons for declining the application.

The application is complete and contains sufficient information to enable consideration of the effects of development and operation of the Activity.

Section 17W of the Act requires consideration of the "Relationship between concessions and conservation management strategies and plans" and states at Section 17W(1):

- (1) Where a conservation management strategy or conservation management plan has been established for a conservation area and the strategy or plan provides for the issue of a concession, a concession shall not be granted in that case unless the concession and its granting is consistent with the strategy or plan.

The West Coast Conservation Management Strategy discussed below. There are no relevant conservation management plans for the area.

## 5.2 Provisions of the Act and the purpose for which the land is held

In considering any application for concession Section 17U(3) of the Act states that:

The Minister shall not grant an application for a concession if the proposed activity is contrary to the provisions of this Act or the purposes for which the land is held.

### 5.2.1 Conservation Act 1987

According to its long title, the Act has been developed, "to promote the conservation of New Zealand's natural and historic resources".

'Conservation' is defined in Section 2 of the Act as:

The preservation and protection of natural and historic resources for the purpose of maintaining their intrinsic values, providing for their appreciation and recreational enjoyment by the public, and safeguarding the options of future generations.

In regard to 'conservation' the terms 'preservation' and 'protection' have the following meanings per Section 2 of the Act:

**Preservation** - in relation to a resource, means the maintenance, so far as is practicable, of its intrinsic values

**Protection** - in relation to a resource, means its maintenance, so far as is practicable, in its current state; but includes—

- (a) its restoration to some former state; and
- (b) its augmentation, enhancement, or expansion'

## 5.2.2 The Department of Conservation

To achieve the intended outcome/purpose of the Act 1987, the Department of Conservation (DOC) was established.

Section 6 of the Act sets out the functions of DOC. In undertaking its functions DOC work with a range of legislation, plans, policies and strategies. Of relevance to this application are the:

- Conservation Act 1987 (Act);
- Conservation General Policy 2005 (CGP); and
- West Coast Conservation Management Strategy 2010-2020 (CMS).

## 5.2.3 Purpose for which the land is held

The Scheme components subject to this application are located within conservation land administered by DOC.

For the purposes of this CMS, the entire West Coast Tai Poutini Conservancy has been divided into seven land-based Places (Karamea, Kawatiri, Paparoa, Inangahua, Māwhera, Hokitika and Te Wāhi Pounamu) and one marine Place. Map 5 of Volume 1 of the CMS shows the Places (see next page).

Volume 2 of the CMS also contains a more detailed set of Maps. It identifies McCulloughs Creek as follows:

- Conservation Area - McCulloughs Creek, Land unit number: I35017, CMS Map sheet 7
- Stewardship Area - s.25 Conservation Act 1987

Map Sheet 7 is also produced on the page following the next one.

The management of land held as Stewardship Area under the Act is set out in Section 25, which provides that:

Every Stewardship area shall so be managed that its natural and historic resources are protected.

In regards to this management requirement the following definitions are provided in the Act,

**Natural resources** means -

- (a) plants and animals of all kinds; and
- (b) the air, water, and soil in or on which any plant or animal lives or may live; and
- (c) landscape and landform; and
- (d) geological features; and
- (e) systems of interacting living organisms, and their environment;

and includes any interest in a natural resource.

**Historic resource** means a historic place within the meaning of the Historic Places Act 1993; and includes any interest in a historic resource.

**Protection** - in relation to a resource, means its maintenance, so far as is practicable, in its current state; but includes—

- (a) its restoration to some former state; and
- (b) its augmentation, enhancement, or expansion'



# MAP 5 CMS Places

## Legend

-  Place boundaries
-  Public conservation land
-  Major Roads / Highways
-  Major Rivers

Kilometres  
20 10 0 20 40 60



In considering the purpose for which the land is held it is also relevant to consider “Part 4 Specially Protected Areas” of the Act. This Part of the Act provides for the gazettal of areas where specific protection or preservation measures are required to conserve high natural and heritage resource values. These Specially Protected Areas include:

- Wetland Areas notified to the Ramsar Secretariat (Section 18AB)
- Conservation Parks (Section 19)
- Wilderness Areas (Section 20)
- Ecological Areas (Section 21)
- Sanctuary Areas (Section 22)
- Watercourse Areas (Section 23)
- Amenity Areas (Section 23A)
- Wildlife Management Areas (Section 23B)

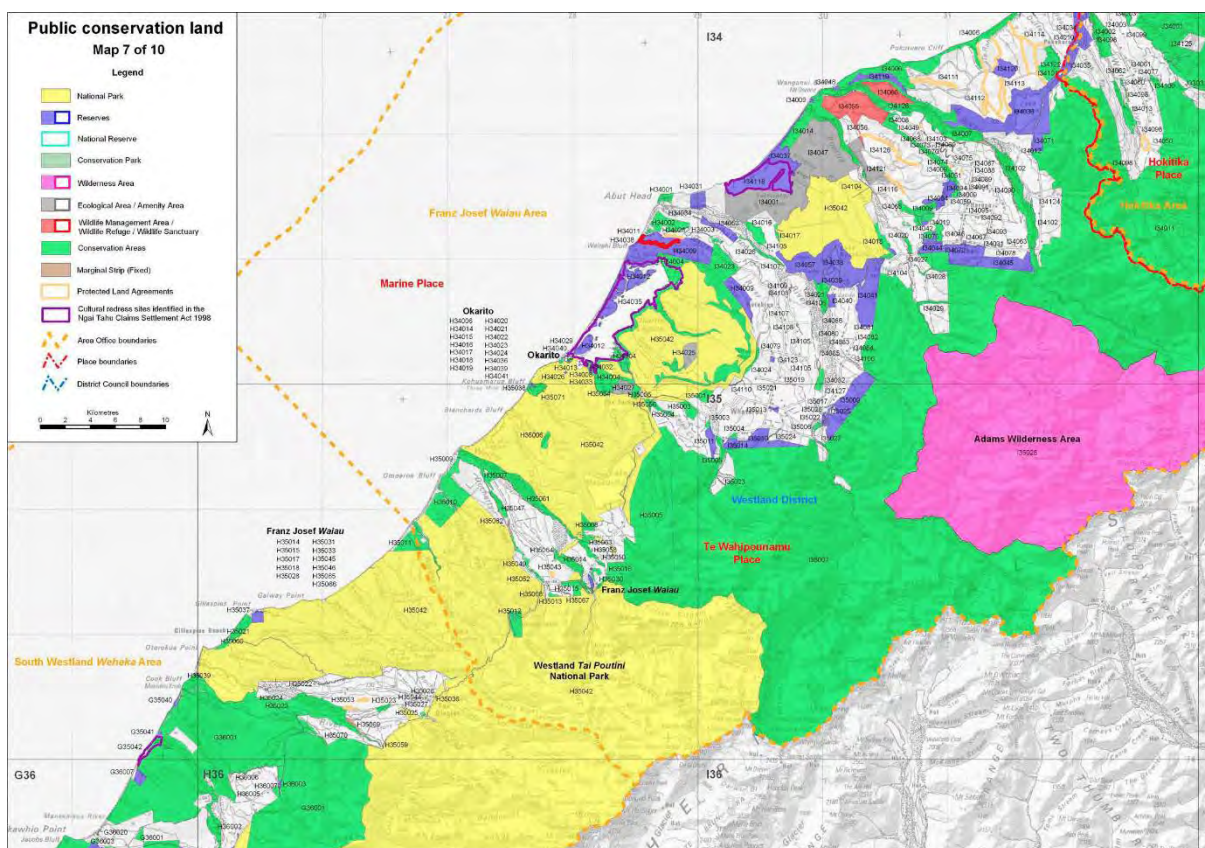

The applicant has undertaken a range of expert assessments to identify natural heritage values and implement a range of measures to avoid, remedy or mitigate potential effects. These measures have been provided for either through the design, layout and location of the Activity, including through the proposed mitigation. The expert conclusion is that with that design and mitigation, the effects will be minor or less than minor. The resources of Mcculloughs Creek will be protected.

## 5.2.4 Conservation General Policy 2005

Section 17A of the Act sets out the linkage between general conservation policies, conservation management strategies and the management and administration of conservation areas and natural and historic resources by DOC. Section 17A states:

Subject to this Act, the Department shall administer and manage all conservation areas and natural and historic resources in accordance with:

- (a) statements of general policy approved under section 17B or section 17C; and
- (b) conservation management strategies, conservation management plans, and freshwater fisheries management plans.

The CGP provides guidance for the implementation of the Act and other conservation related legislation. Any Conservation Management Strategies and Plans prepared under the Act must be consistent with the CGP. The CMS at Objective 1 of Section 3.5 “Authorised Uses of Public Conservation Lands” seeks:

To implement Conservation General Policy 2005 and General Policy for National Parks 2005 when considering applications for authorisations on public conservation lands and waters.

The CMS has been prepared in accordance with the CGP if the CMS is met, it can be considered that the CGP will also be met. Accordingly, only the most relevant Policies of the CGP are referred to here.

### **CGP Policy 4.6 - Ecosystem services**

Policy 4.6(a) states:

Activities on public conservation lands and waters should be planned and managed in ways which avoid or otherwise minimise adverse effects on the quality of ecosystem services.

The Activity has been designed to avoid and / or minimise adverse on the quality of ecosystem services. The effects on ecosystem services are considered to be minor, or less than minor.

### **CGP Policy 9.1 - Planning and management for people’s benefit and enjoyment**

Policy 9.1(a) states:

Recreational opportunities will be provided on public conservation lands and waters. Where provided, they should be consistent with the values of and outcomes planned for places.

As discussed above, the Activity will provide for recreational walking and viewing opportunities – and will enable the enjoyment and use of the land to a greater extent than currently possible.

### **CGP 9.5 - The use of vehicles and other forms of transport**

Policy 9.5(a) states:

The use of vehicles and any other forms of transport should be compatible with the statutory purposes for which the place is held, or be necessary to enable the Department to perform its functions.

The proposal has been carefully designed so that construction can be undertaken without the construction of vehicular access – through the use of helicopters and a pulley system. This means that landscape, vegetation clearance, and other effects associated with providing vehicular access for construction (or permanently for maintenance) has been avoided.

### **CGP Policy 11 - Activities Requiring Specific Authorisation**

Policies 11.1(a)-(d) deal with all activities requiring specific authorisation, including concessions.

These policies state that activities:

- will comply with, or be consistent with, the objectives of the relevant Act, the statutory purposes for which the place is held, and any conservation management strategy or plan;
- should where relevant avoid, remedy or mitigate any adverse effects (including cumulative effects) and maximise any positive effects;
- both the Department and concessionaires should monitor effects, including effects on public enjoyment, to inform future management decisions; and
- concessionaires are to be responsible for the safe conduct of their operations.

These matters are all well addressed, and demonstrated to be met, in the application / EIA.

### **CGP Policy 11.3 - Utilities**

Policy 11.3 states:

- (a) Utilities may be provided for on public conservation lands and waters where they cannot be reasonably located outside public conservation lands and waters, or if specifically provided for as a purpose for which the place is held.
- (b) When new utilities are installed or existing utilities are maintained or extended, they should be of a scale, design and colour that relates to, and is integrated with, the landscape and seascape.
- (c) Public access to utilities may be denied where necessary for the protection of public safety or the security or competent operation of the activity concerned.
- (d) Utilities should, wherever possible, be located in, or added to, an existing structure or facility and use existing access options.
- (e) Utilities that are redundant should be removed from public conservation lands and waters and the site restored as far as practicable to a natural state to minimise effects on the landscape.

Utilities are defined as:

Includes but not limited to: structures and infrastructure for telecommunications; **energy generation** and transmission; sewerage; water supply and flood control; oil and gas; roads and airstrips; hydrological and weather stations. (emphasis added)

Policy 11.3(a) reinforces the consideration required under Part 3B (Section 17(U)(4)(a)) of the Act, which states:

The Minister shall not grant any application for a concession to build a structure or facility, or to extend or add to an existing structure or facility, where he or she is satisfied that the activity:

- (a) could reasonably be undertaken in another location that:
  - (i) is outside the conservation area to which the application relates; or
  - (ii) is in another conservation area or in another part of the conservation area to which the application relates, where the potential adverse effects would be significantly less; or....

It is clear from Policy 11.3 that Utilities, including structures and infrastructure for energy generation, can be provided for on public conservation lands and waters.

The applicant has developed its small-scale hydro-electric power scheme proposal to efficiently use the McCulloughs Stream resource, for the reasons described in sections 1 and 2 (including 2.1.1.1 – “options, alternative locations and siting of project structures”). It is not possible to locate such a scheme outside of the conservation estate.

The scale, design and colour of the activity has been designed to assist integration into the landscape.

#### **Conclusions in respect of Conservation General Policy**

The CGP provides for Utilities to be established on conservation land and waters,

Given the nature and design of the proposed activity, the proposal is considered consistent with (if not supported by) the CGP.

#### **5.2.5 West Coast Conservation Management Strategy 2010-2020**

The CMS provides provisions relating to:

- The management and administration by DOC of conservation areas and natural and historic resources as required under Section 17A of the Act.
- Section 17W of the Act, which provides for the consideration of the consistency between concessions and conservation management strategies and plans and, relevant to this application, states at 17W(1):

Where a conservation management strategy or conservation management plan has been established for a conservation area and the strategy or plan provides for the issue of a concession, a concession shall not be granted in that case unless the concession and its granting is consistent with the strategy or plan.

- Section 17T(2) which provides that the Minister shall decline an application for concession which is inconsistent with a conservation management strategy. Section 17T(2) states:

If the Minister is satisfied that the complete application does not comply with or is inconsistent with the provisions of this Act or any relevant conservation management strategy or conservation management plan, he or she shall, within 20 working days after

receipt of the application, decline the application and inform the applicant that he or she has declined the application and the reasons for declining the application.

There are no conservation management plans relevant to this application.

The CMS at Section 1.1 states that:

This conservation management strategy establishes objectives for the integrated management of natural and historic resources, including species managed under a number of different Acts, and for recreation, tourism and other conservation purposes in the West Coast Tai Poutini Conservancy. It is the key conservation management tool which the Department uses to implement legal, policy and strategic direction. Each conservation management strategy is prepared with public participation.

Seven land based 'Places' and one marine 'Place' have been established. The CMS advises that the boundaries of these 'Places' have been chosen for practical management reasons. Each of the 'Places' set a range of conservation "Outcomes" for the period (2010-2020). The "Outcomes" are topic/issue based descriptions of the anticipated results of implementing the CMS, and associated Objectives and Policies.

The Activity is located within the "Te Wāhi Pounamu Place" (see Section 4.2.7 Desired Outcome for Hokitika Place, page 249, of the CMS).

The relevant stated "Outcomes" relate to:

Outcome in 2020	Section	Page
Geodiversity, landforms and landscapes in 2020	4.2.7.6	256
Indigenous biodiversity	4.2.7.7	257
Human history	4.2.7.8	263
Cultural values of significance to Poutini Ngāi Tahu/Ngāi Tahu	4.2.7.9	266
People's benefit and enjoyment	4.2.7.10	267

Part 3 of the CMS outlines how DOC intends to achieve the outcomes presented within Part 4.

Section 3 is divided into 6 matters relevant to this application:

Matter	Section	Page
Nature Heritage Conservation	3.3	55
Historical and Cultural Heritage	3.4	96
Authorised Uses of Conservation Lands	3.5	111
Peoples Benefit and Enjoyment	3.6	113
Other Use of Public Conservation Lands - Utilities	3.7.11	158
Other Management Responsibilities - Public Access	3.8.4	167

The Objectives and Policies from these sections, where relevant to this application, are discussed below.

## **SECTION 3.3 NATURE HERITAGE CONSERVATION**

### **3.3.2.3 Prioritising natural heritage work**

Policy 1. Natural heritage should be identified and its relative value assessed using standard criteria such as representativeness, viability, diversity, presence of threatened and/or taonga species and their habitat, intactness and natural landscape character.

The expert assessments (eg Wildlands) adopted an approach consistent with this policy to ensure a comprehensive, consistent and sound approach to the assessment.

### **3.3.3.2 Maintenance and restoration of the indigenous natural character of ecosystems**

Objective 1. To maintain, and restore where practicable, the indigenous natural character of the full range of West Coast Te Tai o Poutini terrestrial, freshwater and marine ecosystems.

Policy 1. Management of threats to terrestrial and freshwater species, habitats and ecosystems across all public conservation lands on the West Coast Te Tai o Poutini should be prioritised, taking into account the need to:

- a) prevent the loss of indigenous species and the full range of their habitats and ecosystems;
- b) maintain contiguous sequences of indigenous ecosystems (e.g. from mountains to sea);
- c) maintain representative examples of the full range of indigenous ecosystems;
- d) maintain populations of indigenous species, habitats and ecosystems with unique or distinctive values;
- e) achieve recovery of threatened indigenous species (including their genetic integrity and diversity) and restore their habitats where necessary;
- f) restore threatened indigenous ecosystems and connections between ecosystems where necessary;
- g) maintain the ecological integrity of indigenous ecosystems consistent with the purposes for which the land is held;
- h) protect recreational freshwater fisheries and freshwater fish habitats; and
- i) achieve integrated management at priority sites.

The Activity has been designed with all these matters in mind, including the minimisation of impacts on indigenous species, their habitats, avoiding severance effects etc, with mitigation meaning that the effects will be minor or less than minor.

The Activity is consistent with, if not supported by, this Objective and Policy.

### **3.3.3.3 Management of freshwater fisheries**

Objective 1. To prevent further extinctions of indigenous freshwater fish species and declines in species abundance and range.

Policies 1. Existing and potential threats affecting indigenous fish populations, including barriers to migration (see Policies 2-4), habitat degradation and loss (see Section 3.3.1.5), introduction of pest species (see Policy 9 and Section 3.3.1.5), and interactions between exotic fish, including sports fish, and indigenous fish (see Policy 9) should be addressed.

2. The Department should safeguard fish migration through application of the Freshwater Fisheries Regulations 1983 fish passage provisions, advocacy through local authority planning processes, and monitoring.

4. Where of benefit to native fish species, the Department should advocate for the removal of barriers or the installation of fish passes that allow native fish to travel both upstream and downstream, and monitor the effectiveness of such fish passes.

The Activity, including its intake structure, has been designed to minimise the potential effects on aquatic ecology. The topography means that migration of fish upstream is naturally difficult, and the proposal will not impact on that.

The Activity is consistent with, if not supported by, this Objective and Policies.

### **3.3.3.5 Threatened species management**

Objectives 1. To prevent further extinctions or range contractions of indigenous species found on the West Coast Te Tai o Poutini.

Policy 2. To ensure, where practicable, that representative populations of all indigenous species have long term security in predominantly natural habitats within their natural range.

The Activity will not contribute to the risk of further extinction or range contractions of indigenous species, and will generally maintain the current natural habitats.

The Activity is consistent with, if not supported by, this Objective and Policies.

### **3.3.3.6 Biosecurity and pest management**

Objective 1. To protect natural heritage values from the adverse effects of unwanted organisms, invasive weeds and animal pests.

Policy 3. Public and resource user awareness of the adverse impacts of unwanted organisms on indigenous species and ecosystems, and of ways to avoid their introduction and spread, should be enhanced.

The applicant is aware of the need to minimise the risk of introduction of unwanted pests. Its construction management plans will adopt appropriate protocols to ensure this does not occur during construction. The design will facilitate access, for recreational and scenic uses, but it is not anticipated to be a heavily visited area, so there is limited risk of introduction of pests by the public generally.

The Activity is consistent with, if not supported by, this Objective and Policies.



### **3.3.3.7 Ecosystem services and economic benefits**

Objective 1. To protect the quality of life sustaining ecosystem services.

The Activity will have little or no impact on the quality of the current ecosystem services, let along its life sustaining potential.

The Activity is consistent with, if not supported by, this Objective and Policies.

## **SECTION 3.4 HISTORICAL AND CULTURAL HERITAGE CONSERVATION**

### **3.4.1 Historical and Cultural Heritage Values and Threats**

Objective 1. To gain a better understanding of historical and cultural heritage values and threats and establish priorities for protection and active management, and to enhance people's appreciation.

#### **3.4.1.5 Understanding historical and cultural heritage values**

Policy 7. The New Zealand Archaeological Association database should be maintained and the Conservancy Protection Plan (including land inventories) updated on a regular basis. Information on historical and cultural heritage values should also be incorporated into other databases as applicable.

Policy 10. Where access arrangements authorise an activity in an area with historical and cultural heritage values, a requirement for archaeological surveys and collection of heritage information may be made.

There are no known or identified historic or cultural heritage sites within the Activity area.

Accepted accidental discovery protocols will be adopted to ensure that appropriate action is taken if cultural or heritage items are identified during development.

## **SECTION 3.5 AUTHORISED USES OF PUBLIC CONSERVATION LANDS**

Objectives 1. To implement Conservation General Policy 2005 and General Policy for National Parks 2005 when considering applications for authorisations on public conservation lands and waters.

Objective 2. To protect natural, historical and cultural heritage values from adverse effects of recreation, tourism or other uses.

Objective 5. To consult, where necessary, with Papatipu Rūnanga, conservation boards, the West Coast Fish and Game Council, authorisation holders, communities and other people and organisations over the consideration and granting of concessions, access arrangements and other authorisations for use of public conservation lands.

Policy 1. The cumulative effects of other authorities for use, issued in respect of a particular area or opportunity, should be taken into account when considering new applications for those areas or opportunities.

Policy 2. When approving concessions or other authorisations, specific conditions may be applied as deemed appropriate.

The Activity has been assessed against the CGP above. The proposal is consistent (or supported) with the relevant GCP Policies allowing for Utilities in appropriate circumstances such as this.

In terms of Policy 1, there are no other relevant existing authorities for other uses (eg other concessions).

The Activity is considered consistent with, if not supported by, these Objectives and Policies.

## **SECTION 3.6 PEOPLES BENEFIT AND ENJOYMENT**

### **3.6.1.4 Backcountry-Remote zone**

Objective 1. To provide access to a range of recreational opportunities via facilities that enable people to enjoy challenging natural settings in the backcountry

Objective 2. To enable people to access extensive natural settings where:

- a) facilities are provided but a considerable degree of physical challenge, self-reliance and isolation is involved;
- b) groups of recreational users are generally small and encounters with other groups are infrequent (except on a limited number of high-use tracks and rivers);
- c) huts and tracks provide the opportunity for solitude for those who seek a greater sense of isolation and challenge, but still need the security of some facilities; and
- d) overnight use is more intensive at some sites and at certain times of the year.

Policy 1. The backcountry-remote zone should be managed to meet the desired outcomes described in Part 4 of this CMS and in any relevant management plans, providing facilities and services that cater principally for the needs, interests and abilities of most backcountry comfort seekers and backcountry adventurers.

Policy 8. Irregular and occasional aircraft landings (definitions of these terms are provided in Section 3.6.4.2) may be authorised. Each operator may undertake no more than 2 landings per day, and no more than 20 per annum, at a given location within the backcountry-remote zone.

Policy 10. Where practicable, the aircraft landing sites available to each concessionaire will be specified in concession conditions.

The CMS utilises a zoning system to identify and manage a range of recreation opportunities, in the case of this application the zoning is "backcountry-remote". The CMS states at Section 3.6.1.1, page 114, that:

"The zoning system identifies broad recreation outcomes at Places, by describing where the major recreational facilities and services are and thereby identifying the areas that will remain free of high levels of public use because of a lack of, or lower grade, facilities. Detailed descriptions of recreation outcomes for specific locations within each Place are provided in Part 4, Chapter 4.2, under the subheading 'Recreation and tourism in 2020'.

The Activity will not interfere with any recreational use. To the contrary, it will assist in providing an access track and viewing platform where there is presently none.

Some helicopter air traffic movements will be required for construction, and, potentially for maintenance activities. These will be limited and consistent with the policy requirements – as addressed below.

Accordingly, the Activity is considered consistent with these Objectives and Policies.

### 3.6.4.2 Aircraft

Policies 1. Aircraft may be authorised to land within public conservation lands where this:

- a) is necessary for the Department to perform its functions; or
- b) facilitates access for emergency or search and rescue purposes; or
- c) is compatible with the statutory purposes for which the place is held and consistent with any relevant national park management plan; and
- d) is consistent with the objectives and policies for the relevant recreational zone/s (see Sections 3.6.1.2 to 3.6.1.6); and
- e) does not compromise the desired outcomes for Places (see Part 4, Chapter 4.2).

Clauses (c)-(e) apply to applications for aircraft landings associated with recreation and tourism purposes (e.g. scenic flights, recreational access to the backcountry, private landings) and nonrecreational purposes (e.g. wild animal recovery operations, provision and servicing of utilities, mining, management of the pouamu resource, filming and other commercial activities).

Policy 2. Aircraft landing sites on West Coast Te Tai o Poutini public conservation lands will be assigned to one of the following four categories, depending on which recreational zone the site is located in and the legal status of the site:

Excluded: Aircraft landings should be excluded except for conservation management purposes, emergencies or search and rescue purposes.

Regular: Regular landings are defined as occurring when a concessionaire undertakes 3 or more landings per day and/or 21 or more landings per annum, at specific sites. Regular landings may only be authorized within the backcountry-remote zone and may occur all-year-round or on a seasonal basis. Numbers and frequencies of landings should be considered on a case-by-case basis.

Irregular: Irregular landings are defined as no more than 2 landings per day, and no more than 20 per annum, at a given location. Landings may be authorised for the purposes of transportation of personnel and/or equipment to or from a variety of possible locations within the remote or backcountry-remote zones, or at frontcountry sites. This provides for landings for air charter purposes, but does not include regular landings at specific sites or scenic snow landings.

Occasional: 'One-off' permits for landings may be granted for specific purposes (short-term, one-off events such as filming, management of utilities) at specific sites within the remote or backcountry-remote zones, or at frontcountry sites.

6. Regular aircraft landings should be restricted to specified landing sites, where practicable.

This policy does allow for the authorisation of helicopter landings within the Stewardship Area.

During construction, some helicopter movements will be required. These will be minimal, and over a limited period of time.

It is considered that the Activity is consistent with this policy.

## **SECTION 3.7 OTHER USE OF PUBLIC CONSERVATION LANDS**

### **3.7.2 Activities on or in Beds of Rivers or Lakes**

Policies 1. When assessing applications for any activity on or in the bed of a river or lake, consideration should be given to (but not limited to) the following guidelines:

- a) Adverse effects on freshwater and terrestrial species, habitats and ecosystems, historical and cultural heritage values, public access, recreation opportunities and amenity values should be avoided or otherwise minimised;
- b) Riparian vegetation should be maintained or enhanced;
- c) Activities should not damage riverbanks;
- d) No pests, weeds or other unwanted organisms (e.g. Didymo) should be likely to be introduced to, or become established within, the area as a result of the activity; and
- e) The natural character within the setting of the activity should be maintained.

Policy 2. Biological communities, physical habitat, channel profiles and substrate may be monitored, in order to evaluate and manage the long term impacts of activities occurring on or in the beds of rivers or lakes.

The proposal has carefully considered, minimised, and assessed the effects arising from its proposed intake structure, diversion, and discharge. They have been assessed as minor or less than minor, given the design and mitigation proposed.

It is therefore considered that the Activity is consistent with these Policies.

#### **3.7.11 Utilities**

Policy 3. The development, installation, maintenance and management of utilities on public conservation lands should be consistent with the desired outcome for the relevant place/s (see Chapter 4.2).

The proposed development, installation, maintenance and management of the Scheme on conservation land will not compromise the desired "Outcomes".

It is therefore considered that the Activity is consistent with this Policy.

## **3.8 OTHER MANAGEMENT RESPONSIBILITIES**

### **3.8.4 Public Access**

Objective 1. To provide for public access to conservation areas in ways that meet people's reasonable aspirations but do not compromise public safety or the protection of conservation values.

Policy 3. Activities and access to public conservation lands may be restricted in accordance with legislation:

- a) where necessary to protect natural, historical or cultural heritage values; or
- b) where a particular activity will adversely affect the enjoyment of the area by other people, including the qualities of solitude, remoteness, wilderness, peace and natural quiet, where these qualities are present; or
- c) where a particular activity will prevent the desired outcome for a Place from being achieved (see Part 4); or
- d) for public health and safety reasons.

Approval of the concession will not prevent public access to and along the conservation land in the vicinity of the scheme. Any restrictions on access to pieces of DOC land within the concession area will be relatively minor and will not restrict access through the area.

In fact, the proposal will facilitate better public access to the area through its access track and viewing platform.

It is considered that the Activity, and concession, is consistent with this policy.

#### **Section 4.2.7 Desired Outcome for Te Wāhi Pounamu Place.**

Based on the above assessment of the provisions of the Act, purpose of Stewardship land, the CGP and the Objectives and Policies of the CMS the Activity and concession, will not compromise the conservation "Outcomes" for the 'Te Wāhi Pounamu Place' in 2020.

#### **5.2.6 Location on conservation land**

Section 17U(4) requires that:

The Minister shall not grant any application for a concession to build a structure or facility, or to extend or add to an existing structure or facility, where he or she is satisfied that the activity—

- a) could reasonably be undertaken in another location that—
  - (i) is outside the conservation area to which the application relates; or
  - (ii) is in another conservation area or in another part of the conservation area to which the application relates, where the potential adverse effects would be significantly less; or
- b) could reasonably use an existing structure or facility or the existing structure or facility without the addition.

These matters are discussed above under CGP Policy 11.3 which states,

Utilities may be provided for on public conservation lands and waters where they cannot be reasonably located outside public conservation lands and waters, or if specifically provided for as a purpose for which the place is held.

As discussed above it is clear from CGP Policy 11.3 that Utilities, including structures and infrastructure for energy generation, can be provided for on public conservation lands and waters where they cannot be reasonably located outside public lands and waters.

As the applicant's evaluation demonstrates, there are no reasonable other options/alternatives for development of a hydro-electric power scheme of the nature proposed other than within the at the proposed location within the conservation estate. Accordingly it is not considered reasonable to locate the Activity outside conservation land or waters.

### 5.2.7 Granting of lease or licence

Section 17U(5), (6) and (7) relate to types of concession and limitation on granting a lease or licence, stating:

- (5) The Minister may grant a lease or a licence (other than a profit à prendre) granting an interest in land only if—
  - (a) the lease or licence relates to 1 or more fixed structures and facilities (which facilities do not include any track or road except where the track or road is an integral part of a larger facility); and
  - (b) in any case where the application includes an area or areas around the structure or facility,—
    - (i) either—
      - (A) it is necessary for the purposes of safety or security of the site, structure, or facility to include any area or areas (including any security fence) around the structure or facility; or
      - (B) it is necessary to include any clearly defined area or areas that are an integral part of the activity on the land; and
    - (ii) the grant of a lease or licence granting an interest in land is essential to enable the activity to be carried on.
- (6) No lease may be granted unless the applicant satisfies the Minister that exclusive possession is necessary for—
  - (a) the protection of public safety; or
  - (b) the protection of the physical security of the activity concerned; or
  - (c) the competent operation of the activity concerned.
- (7) For the purposes of subsection (6), the competent operation of an activity includes the necessity for the activity to achieve adequate investment and maintenance.

Types of concession applied for, and required, are set out in Section 3 of this application, and discussed above in terms of access to structures and facilities. There are requirements that aspects of the Scheme are exclusive to ensure public safety, security of infrastructure and operation and maintenance of the Scheme.

The appropriate forms of concession will be determined by DOC. However, the following table outlines the components of the Activity and the likely type of concession required.

	Scheme Component	Indicative Concession Type
Intake	Permanent intake structures - Concrete overflow weir with Coanda screen intake design. - Pipeline leading to the desander (above the river bank)	Lease
Desander	Permanent desander “unit”, located above the river bank.	Lease
Penstock	Permanent, above ground penstocks (low and high pressure sections), with appropriate support structures.  Includes access widths for maintenance.	Lease
Powerhouse	Powerhouse and tailrace structures	Lease
Access Route	Permanent (foot) access route, including possible viewing platform. Will be available for public use on completion.	Easement.
Temporary additional construction and work areas.	Including a temporary cableway, cleared area for helicopter landing, etc.	Licence.

### 5.3 Term and expiry date

This application is for a term of 40 years, intended to “tie into” the term of the relevant resource consents sought for the Activity.

It is appropriate, if the resource consents are granted for that term, for the applicant to have the certainty of the relevant concession (ie property right). It is also appropriate, notwithstanding the small scale of the scheme, to reflect the investment commitment and represents an efficient use of resources (compared to having a short term, where the infrastructure might need to be removed at the end of the term).

## 5.4 Conclusion

In assessing the concession application, the Minister must consider a number of matters as set out in Part 3B of the Act, including:

- the effects of the proposed activity, and the possible avoidance and mitigation measures available and proposed;
- whether the concession is consistent with the CMS;
- the values of the natural and historic resources the Stewardship Land status seeks to protect;
- whether the granting of the concession application, with or without conditions, would be contrary to the purpose of a Stewardship Area; and
- whether the granting of the concession application, with or without conditions, would be contrary to the provisions of the Act.

The applicants proposed Activity will have minor or less than minor effects. It is consistent with, or supported by, all relevant objectives and policies in the GCP and CMS.

It is appropriate for the concessions sought to be granted.



## APPENDIX A – McCulloughs Creek Hydropower Project and Project Application Corridor

Whataroa Hydropower Scheme - Corridors and Footprints

This page has intentionally been left blank

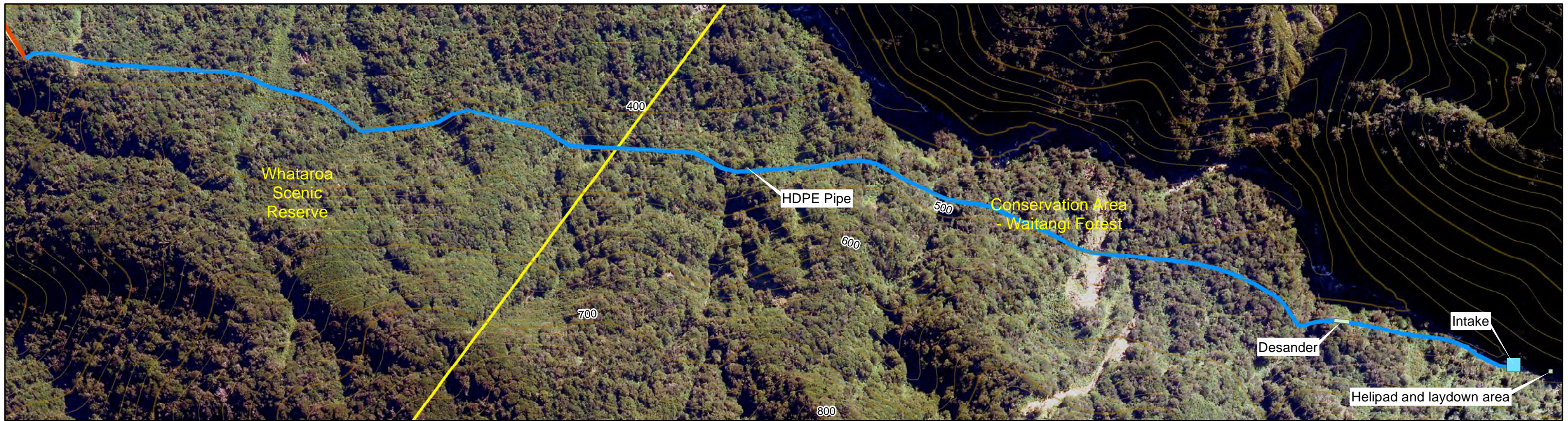
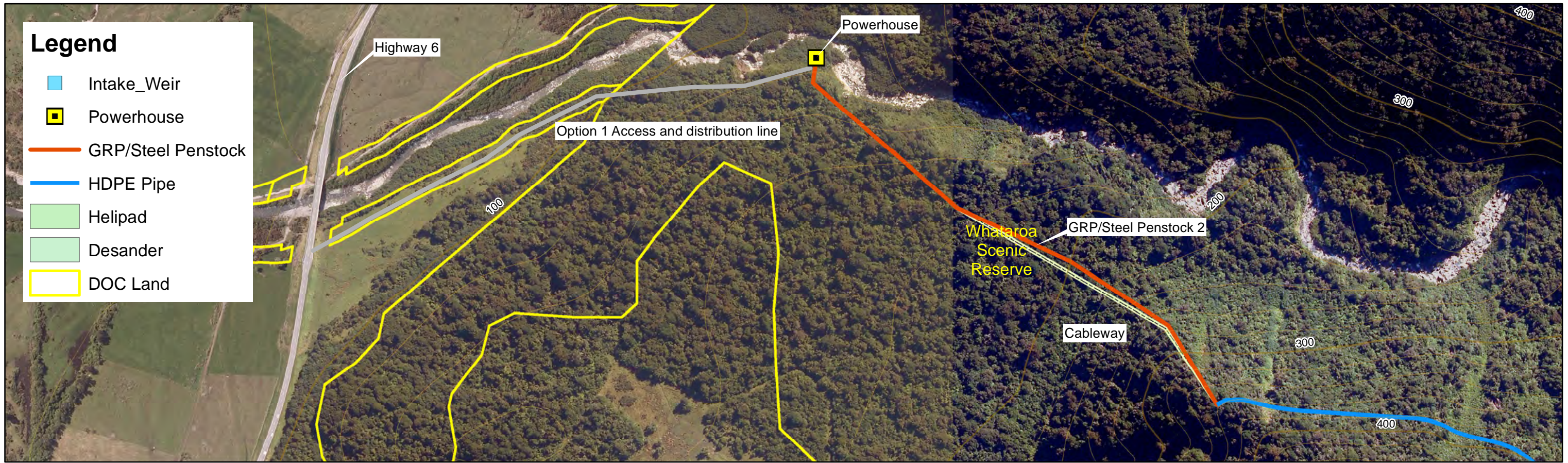

# McCulloughs Creek Hydropower Project

General Site Plan

No.8 Limited



Date	16/08/2017
Drawn	JKJ
Scale	1:5,000
Projection	NZGD 2000 NZTM



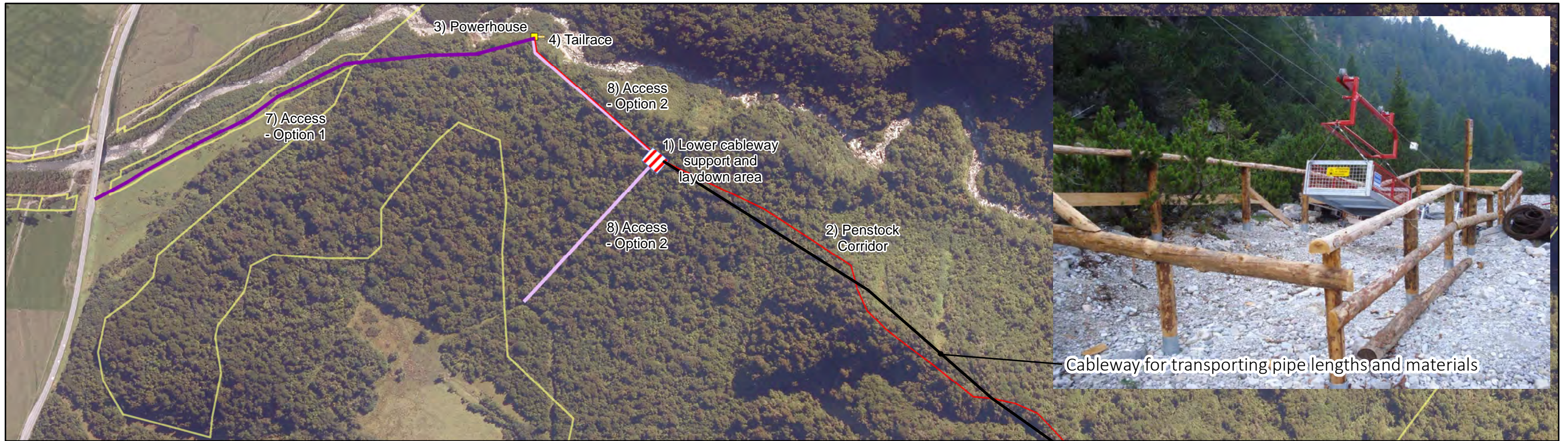

Whataroa Hydropower Scheme - Corridors and Footprints

No 8 Limited

Coordinate System: NZGD2000 New Zealand Transverse Mercator 2000  
 Projection: Transverse Mercator  
 Datum: NZGD 2000



Date: 28/07/2016  
 Author: JKJ





**No.8 Limited**

McCulloughs Creek Hydropower Project

View at Intake Site



Date	16/08/2017
Drawn	JKJ
Scale	1:100
Projection	NZGD 2000 NZTM



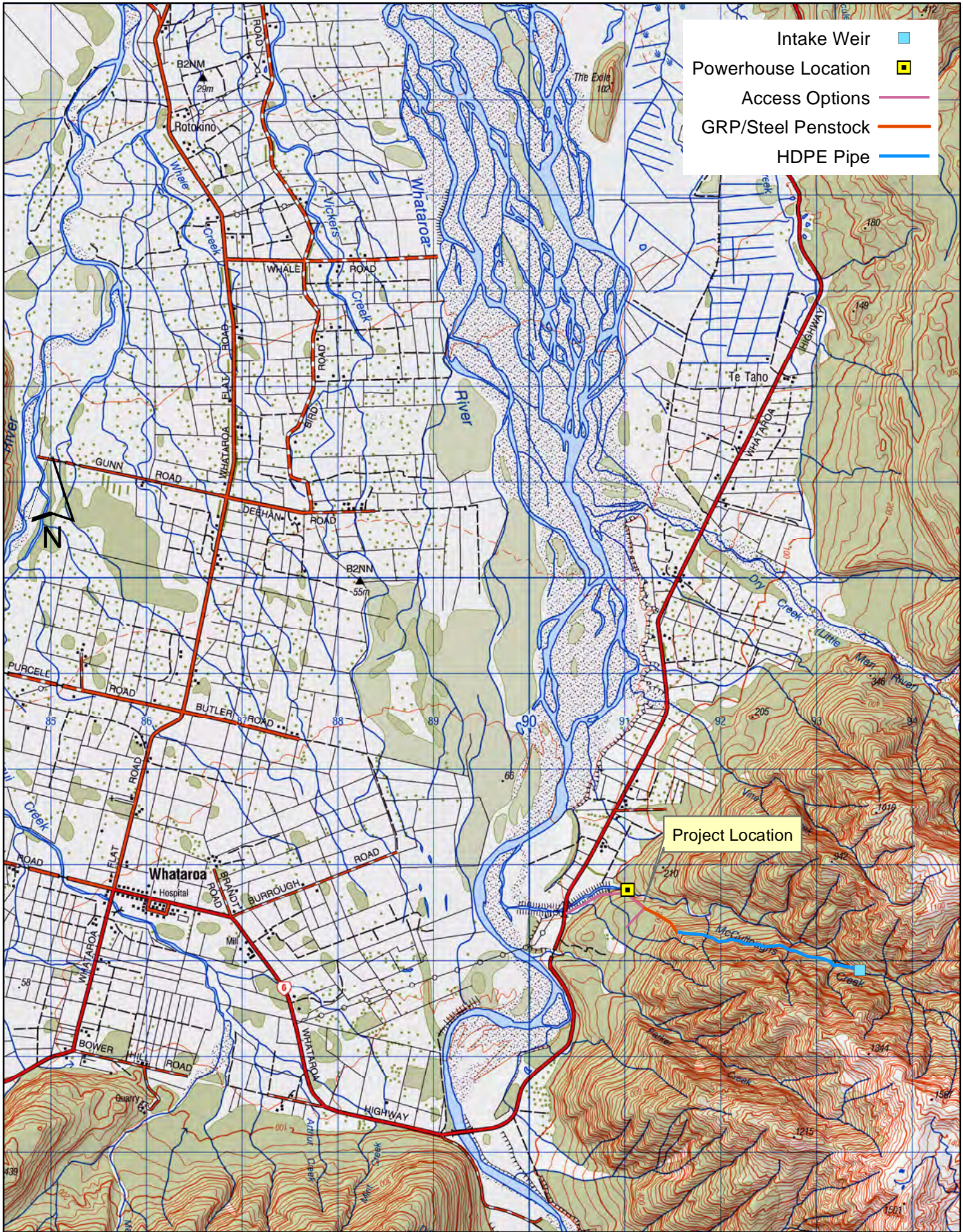

- Intake Weir ■
- Powerhouse Location ■
- Access Options —
- GRP/Steel Penstock —
- HDPE Pipe —

Project Location

**No.8 Ltd**

McCulloughs Creek Hydropower Project  
General Location

Date 24/08/2017  
 Drawn JKJ  
 Scale 1:50,000  
 Projection NZGD 2000 NZTM



## APPENDIX B – Wildlands Ecological Assessment Report

This page has intentionally been left blank

# ECOLOGICAL ASSESSMENT FOR THE PROPOSED MCCULLOUGH'S CREEK HYDROPOWER PROJECT, WHATAROA, WESTLAND

---



 providing  
outstanding  
ecological  
services to  
**sustain**  
and improve our  
environments







# ECOLOGICAL ASSESSMENT FOR THE PROPOSED MCCULLOUGH'S CREEK HYDROPOWER PROJECT, WHATAROA, WESTLAND

---



## **Contract Report No. 4205**

August 2017

### **Project Team:**

Melissa Hutchison - Field survey, report author (vegetation, flora, avifauna)  
Helen McCaughan - Field survey, report author (freshwater ecology)  
Brian Patrick - Field survey, report author (freshwater invertebrates)

### **Prepared for:**

No.8 Limited  
Level 1, 26 Crummer Road  
Grey Lynn  
Auckland



# CONTENTS

1.	INTRODUCTION	1
2.	ECOLOGICAL CONTEXT	1
2.1	Central Westland/Te Wāhi Pounamu	1
2.2	Wilberg Ecological District	3
2.3	Whataroa Scenic Reserve	4
2.4	Whataroa River catchment	5
3.	METHODS	6
3.1	Literature review	6
3.2	Field survey	6
3.2.1	Vegetation and flora	6
3.2.2	Avifauna	6
3.2.3	Freshwater fish and macroinvertebrates	6
3.3	Ecological significance assessment	7
4.	TOPOGRAPHY AND RAINFALL OF THE PROJECT AREA	7
5.	VEGETATION	9
5.1	Overview	9
5.2	Upper site: Intake and helicopter landing pad	10
5.3	Pipeline/penstock corridor	11
5.4	Lower site: powerhouse and access road	12
6.	FLORA	12
7.	TERRESTRIAL FAUNA	13
7.1	Avifauna	13
7.2	Introduced mammals	13
8.	FRESHWATER ECOSYSTEM	13
8.1	Habitat character	13
8.2	Fish and macroinvertebrates	14
9.	ECOLOGICAL SIGNIFICANCE ASSESSMENT	15
10.	PROPOSED WORKS	17
11.	ASSESSMENT OF POTENTIAL EFFECTS	23
11.1	Vegetation	23
11.1.1	Construction effects	23
11.1.2	Operational effects	25
11.2	Freshwater habitat, fish and macroinvertebrates	26
11.2.1	Construction effects	26
11.2.2	Operational effects	26

12.	MEASURES TO AVOID, REMEDY, AND/OR MITIGATE POTENTIAL ADVERSE EFFECTS	28
12.1	Vegetation	28
12.1.1	Construction phase	28
12.1.2	Operational phase	29
12.2	Freshwater habitat, fish and macroinvertebrates	29
12.2.1	Construction phase	29
12.2.2	Operational phase	30
13.	CONCLUSIONS	32
	ACKNOWLEDGEMENTS	32
	REFERENCES	33
	APPENDICES	
1.	Plant species list for McCulloughs Creek Hydropower Project area	35
2.	Key freshwater fish spawning and migration times	37

**Reviewed and approved for release by:**



---

W.B. Shaw  
 Director/Principal Ecologist  
 Wildland Consultants Ltd

© *Wildland Consultants Ltd* 2017

This report has been produced by Wildland Consultants Ltd for No.8 Limited. All copyright in this report is the property of Wildland Consultants Ltd and any unauthorised publication, reproduction, or adaptation of this report is a breach of that copyright.

# 1. INTRODUCTION

No.8 Ltd proposes to construct and operate a 1,890 kW hydropower scheme at McCulloughs Creek, which is situated near Whataroa on the West Coast of the South Island (Figure 1). The project - referred to as the McCulloughs Creek Hydropower Project - consists of an upstream water intake, above-ground pipeline and penstock, powerhouse and discharge tailrace, along with an associated vehicle access road.

The proposed project is located on public conservation land in Whataroa Scenic Reserve (769 hectares), Waitangi Forest (57,326 hectares, Stewardship Land), and McCulloughs Creek Marginal Strip, all administered by the Department of Conservation. This area is part of the Upper Whataroa Priority Site for Biodiversity Management (Department of Conservation 2010). A concession to construct and operate the proposed hydropower scheme is required from the Department under the Conservation Act 1987. Resource consents to construct and operate the scheme are required from the West Coast Regional Council and Westland District Council (under the Resource Management Act 1991).

No.8 Ltd commissioned Wildland Consultants Ltd to carry out an ecological assessment of the McCulloughs Creek Hydropower Project, addressing vegetation, freshwater fish and macroinvertebrates. Potential effects on birds, lizards, bats, and the marine ecosystem were not assessed. This report provides a description of the ecological values of the project area, an assessment of the likely effects of the project on those values, and measures to avoid, remedy and/or mitigate potential adverse effects.

## 2. ECOLOGICAL CONTEXT

### 2.1 Central Westland/Te Wāhi Pounamu

#### Vegetation

Past glacial activity, whereby ice age glaciers scraped the landscape clear of forest, is a distinctive feature of the vegetation in central Westland/Te Wāhi Pounamu (Department of Conservation 2010). This is most clearly illustrated by the 'beech gap' i.e. the general absence of beech (*Lophozonia menziesii* and *Fuscopora* spp.) between the Taramakau and Pāringa Rivers, apart from a few outliers in the Karangarua and Mahitahi catchments (*ibid*). Patterns of plant colonisation and soil formation following the retreat of glacial ice are evident in the present day character of the Franz Josef and Fox Glacier valleys.

In central Westland, a wide variety of natural landforms and indigenous plant communities have remained relatively intact, from the mountains to the sea (Department of Conservation 2010). Indigenous vegetation types include:

- Podocarp-broadleaf forest dominated by rimu (*Dacrydium cupressinum*) on the better-drained parts of the lowland moraine hill country and glacial outwash terraces (some of the densest rimu forest in New Zealand occurs in the Ōkārito, Waikūkupa, and Karangarua forests).
- Kahikatea (*Dacrycarpus dacrydioides*) forest on the wetter flood plain areas.

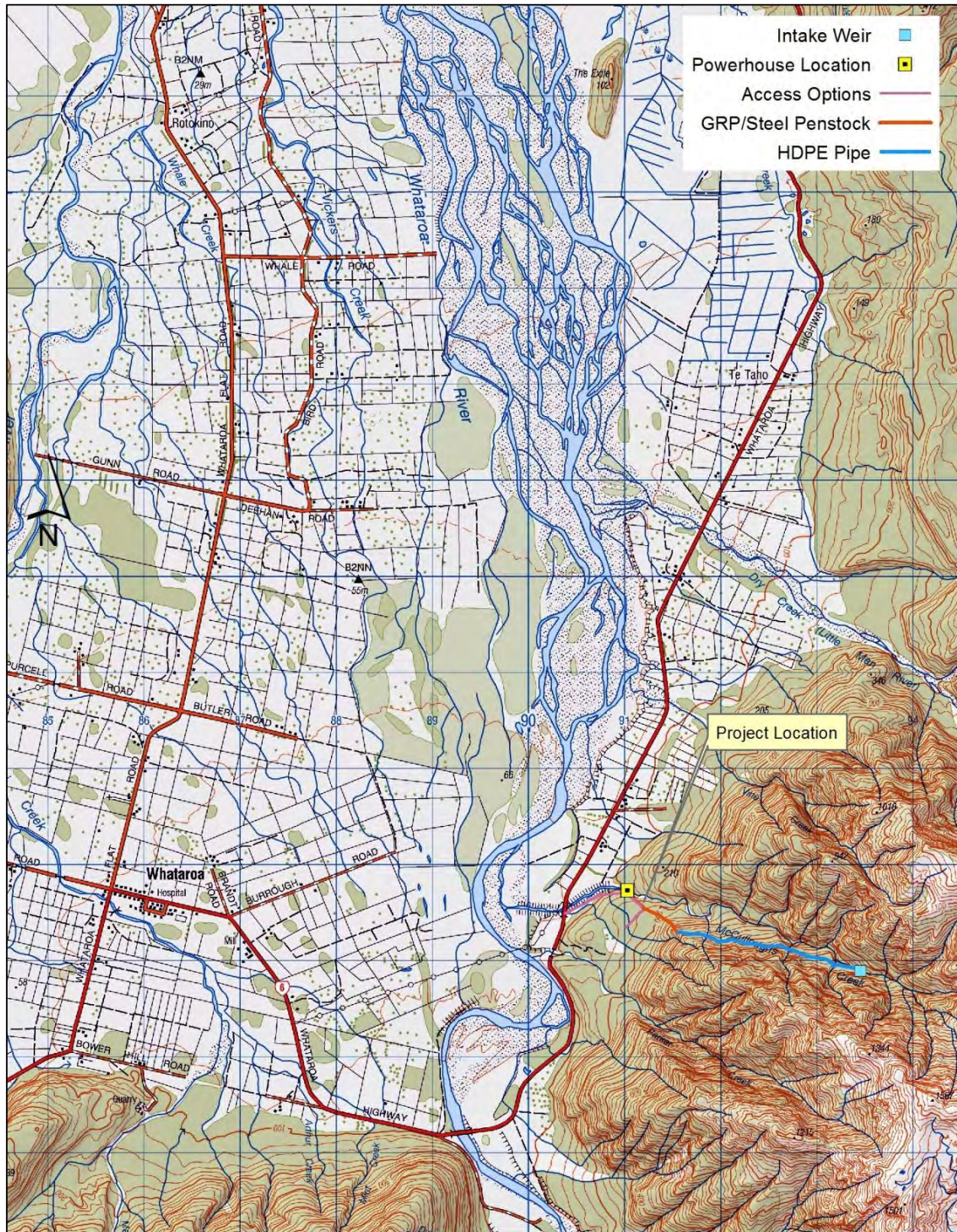

 <b>Wildlands</b>	<b>McCulloughs Creek Hydropower Project</b>	Date	24/08/2017
	<b>General Location</b>	Drawn	JKJ
		Scale	1:50,000
		Projection	NZGD 2000 NZTM

Figure 1: Location of the McCulloughs Creek Hydropower Project, near Whataroa on the West Coast of the South Island (map supplied by No.8 Ltd, August 2017).

- Mataī/tōtara (*Prumnopitys taxifolia*-*Podocarpus totara*) forest on well-drained parts of recent alluvial floodplains (now confined to a few remnants in the major river valleys).
- Silver pine (*Manoao colensoi*), yellow-silver pine (*Lepidothamnus intermedius*), stunted rimu and mountain toatoa (*Phyllocladus alpinus*) on the many poorly-drained sites among the lowland moraine hills.
- Southern rātā/kāmahi (*Metrosideros umbellata*-*Weinmannia racemosa*) forest on the lower slopes of the main ranges and montane valleys.
- An extensive subalpine scrub zone, which is dominated by various tree daisies (*Olearia* spp.) and grass tree species (*Dracophyllum* spp.).

## 2.2 Wilberg Ecological District

The McCulloughs Creek Hydropower Project is located within Wilberg Ecological District, which is part of Whataroa Ecological Region (McEwen 1987). The western boundary of the project area adjoins Harihari Ecological District. Almost all of Wilberg Ecological District is public conservation land.

### Topography, Geology, and Climate

Wilberg Ecological District comprises the mountains inland from Harihari, which have been formed from metamorphic rocks, mostly Haast schists, grading into Torlesse Supergroup greywacke and argillite towards the east (McEwen 1987). Summits are glaciated, although less than 2,700 metres above sea level (asl). Soils consist of strongly-leached stony steepland soils, grading at higher altitudes into alpine soils, with large areas of scree and bare rock. On easier slopes drainage may be impeded and topsoils are peaty. The Ecological District has a high rainfall mountain climate, with rainfall ranging from 5,000-8,000 mm per annum.

### Vegetation

The vegetation within Wilberg Ecological District is almost entirely indigenous (99.0% of the current vegetation cover is indigenous) (Landcare Research 2015). Indigenous forest covers 32.5% of the Ecological District (27,345 hectares out of the total 84,108 hectares), while subalpine shrubland covers 21.1%, tall tussock grassland covers 16.7%, and alpine grass and herbfield covers 3.6% of the Ecological District (Landcare Research 2015).

Wilberg Ecological District contains a sequence of vegetation belts that are characteristic of high rainfall areas where beech forest is absent: with mixed podocarp-hardwood forest on the lower slopes of the mountains, rātā-kāmahi forest at higher altitudes, grading into an extensive subalpine scrub zone, then snow tussock grassland, cushion bogs, herbfield and alpine vegetation at high altitudes (McEwen 1987). Vegetation and flora of the District are relatively poorly known (McEwen 1987).

Three indigenous plant species are known to reach their national southern limits in the adjacent Harihari Ecological District: hīnau (*Elaeocarpus dentatus*), toro (*Myrsine salicina*), and *Cordyline banksii* (McEwen 1987).



## Avifauna

Extensive indigenous forest in Wilberg Ecological District supports a diverse avifauna, although bird densities are generally moderate, probably at least partly limited by the uniformity of the vegetation (McEwen 1987) and undoubtedly by predation by introduced mammals. Indigenous bird species recorded in the Ecological District (McEwen 1987) include:

- Kākā (*Nestor meridionalis*, At Risk-Recovering<sup>1,2</sup>): in forested areas.
- Kea (*Nestor notabilis*, Threatened-Nationally Endangered): above the treeline.
- New Zealand falcon/kārearea (*Falco novaeseelandiae*, Threatened-Nationally Vulnerable): throughout.
- Blue duck/whio (*Hymenolaimus malacorhynchos*, Threatened-Nationally Vulnerable): on some of the rivers.

A number of other indigenous bird species have been recorded in the adjacent Harihari Ecological District (McEwen 1987):

- Rifleman (*Acanthisitta chloris chloris*, At Risk-Declining): widespread in forest.
- South Island robin (*Petroica australis*, At Risk-Declining): widespread in forest.
- Yellow-crowned parakeet/kākāriki (*Cyanoramphus auriceps*, Not Threatened).
- Fernbird (*Bowdleria punctata*, At Risk-Declining).
- Western weka (*Gallirallus australis australis*, At Risk-Declining): only in Saltwater State Forest.
- White heron/kōtuku (*Ardea modesta*, Threatened-Nationally Critical): the only New Zealand breeding colony occurs at Ōkārīto Lagoon.
- Southern crested grebe/pūtekeke (*Podiceps cristatus*, Threatened-Nationally Vulnerable): Lake Ianthe and Lake Rotokino.
- Southern blue penguin (*Eudyptula minor*, At Risk-Declining): breeds at the Wanganui River mouth.

## Introduced Mammals

Introduced mammals present in Harihari and Wilberg Ecological Districts include red deer (*Cervus elaphus*), goats (*Capra hircus*), possums (*Trichosurus vulpecula*), thar (*Hemitragus jenkinsi*), chamois (*Rupicapra rupicapra rupicapra*), rats (*Rattus norvegicus*, *R. rattus*) and mice (*Mus musculus*) (McEwen 1987). Hedgehogs (*Erinaceus europaeus*), stoats (*Mustela erminea*), weasels (*Mustela nivalis*) and ferrets (*Mustela furo*) will also be present.

### 2.3 Whataroa Scenic Reserve

Very little information is available on the ecological values of the McCulloughs Creek Hydropower Project area, but a brief description of the vegetation and birds in Whataroa Scenic Reserve is provided in a report on the Protected Natural Areas of New Zealand (Wassilieff and Timmins 1984). The report lists the following vegetation types in Whataroa Scenic Reserve:

---

<sup>1</sup> New Zealand conservation status according to Robertson *et al.* (2016).

<sup>2</sup> See Townsend *et al.* (2008) for an explanation of the categories in the New Zealand Threat Classification System.

- Kāmahi forest on steep slopes, with stands of rātā of similar ages on spurs, and scattered rimu emergent on slopes in the south.
- (Rimu-miro (*Prumnopitys ferruginea*))/kāmahi treeland with pigeonwood (*Hedycarya arborea*) and supplejack (*Ripogonum scandens*) on terrace remnants uplifted along the Alpine fault.
- Young kāmahi-pigeonwood-māhoe (*Melicytus ramiflorus*)-kaikōmako (*Pennantia corymbosa*) forest on lower fans, with abundant podocarp seedlings.
- Scrub and young forest on recent flats, stream beds and talus.

Indigenous birds recorded in Whataroa Scenic Reserve include bellbird/korimako (*Anthornis melanura*), grey warbler/riroriro (*Gerygone igata*), South Island fantail/pīwakawaka (*Rhipidura fuliginosa fuliginosa*), and South Island tomtit/miromiro (*Petroica macrocephala*) (Wassilieff and Timmins 1984). All of these species are classified as ‘Not Threatened’ (Robertson *et al.* 2016).

## 2.4 Whataroa River catchment

McCulloughs Creek flows into the Whataroa River which is a braided system that flows in a northwesterly direction along mostly pastureland flats to enter the Tasman Sea. Tributary waterways to the Whataroa River flow down the steep forested inclines of the Wilberg, Adams and Price ranges. Small lakes, lagoons and wetland areas are also present in this catchment, which appears to be relatively unmodified.

A search of the New Zealand Freshwater Fish Database was carried out for the Whataroa River catchment. Eight indigenous and one introduced fish species, and the indigenous freshwater crayfish/kōura (*Paranephrops* sp.) have been recorded in the Whataroa River and its tributaries (Table 1).

Table 1: Freshwater fish and invertebrate species recorded in the Whataroa River catchment (New Zealand Freshwater Fish Database, accessed 6 June 2017).

Common Name	Scientific Name	Conservation Status
Longfin eel/tuna	<i>Anguilla dieffenbachi</i>	At Risk-Declining <sup>1</sup>
Giant kōkopu	<i>Galaxias argenteus</i>	At Risk-Declining <sup>1</sup>
Kōaro	<i>Galaxias brevipinnis</i>	At Risk-Declining <sup>1</sup>
Inanga	<i>Galaxias maculatus</i>	At Risk-Declining <sup>1</sup>
Brown mudfish	<i>Neochanna apoda</i>	At Risk-Declining <sup>1</sup>
Shortfin eel/tuna	<i>Anguilla australis</i>	Not Threatened <sup>1</sup>
Banded kōkopu	<i>Galaxias fasciatus</i>	Not Threatened <sup>1</sup>
Common bully	<i>Gobiomorphus cotidianus</i>	Not Threatened <sup>1</sup>
Brown trout	<i>Salmo trutta</i>	Introduced and Naturalised <sup>1</sup>
Freshwater crayfish/kōura	<i>Paranephrops</i> sp.	Not Threatened <sup>2</sup>

<sup>1</sup> Goodman *et al.* 2014.

<sup>2</sup> Grainger *et al.* 2014.

## 3. METHODS

### 3.1 Literature review

A literature search for existing ecological information on McCulloughs Creek and the surrounding area was undertaken, in order to be able to evaluate the ecological values of the project area within a wider context. This included databases such as the New Zealand Freshwater Fish Database and the West Coast *Tai Poutini* Conservation Management Strategy (Department of Conservation 2010).

### 3.2 Field survey

#### 3.2.1 Vegetation and flora

A vegetation survey was carried out in overcast weather on 16 May 2017. The entire project area could not be surveyed, due to difficulty of access and time constraints, so the field survey focussed on several key areas:

- Upper site: proposed helicopter landing pad and intake site.
- Upper section of the proposed pipeline corridor and the lower section of the proposed penstock corridor.
- Lower site: proposed powerhouse and access road.

GPS tracks of the routes traversed during the vegetation survey are shown in Figure 2. The upper site was reached via helicopter and the upper section of the pipeline corridor was then traversed on foot. The lower site was accessed on foot via McCulloughs Creek and the lower section of the penstock corridor was traversed on foot.

During the field visit, all vascular plant species observed were recorded, and notes were compiled on their relative abundance.

Vegetation in the project area was classified into different types using the Atkinson (1985) method. In this method, the types are classified according to the dominant species in each vegetation tier and the main structural class (or classes) of the vegetation.

#### 3.2.2 Avifauna

Incidental observations of birds were made during the field visit on 16 May 2017.

#### 3.2.3 Freshwater fish and macroinvertebrates

Two sites on McCulloughs Creek were surveyed for freshwater fauna, and physical habitat was visually assessed at the same sites (Figure 2). On 14 December 2016 brief invertebrate observations were made at the downstream site only, in the vicinity of the proposed power station and tailrace. Sweep netting was carried out amongst the immediate riparian vegetation, and in the water of the Creek cobbles and gravels were lifted and replaced.

To confirm fish species presence, an electric fishing survey was carried out at an upstream and downstream site on 16 May 2017, using a NIWA EFM300 backpack electric fishing

machine set at 300 volts. At the upstream site, in the vicinity of the proposed intake, a 130 metre reach of the Creek was spot-fished in order to sample all in-stream habitat types (between Sites 01 and 02 on Figure 2). At the downstream site a 140 metre reach of the Creek was spot-fished in order to sample all in-stream habitat types (between Sites 03 and 04 on Figure 2). These reaches could not be comprehensively fished because of the water depth and velocity of some sections.

All fish captured were identified to species, counted and measured. Length measurements were taken from tip of nose to end of tail and recorded to the nearest millimetre (total length, mmTL). Fish seen, but not caught, were recorded if they could be identified to species. No specific work was carried out during the electric fishing survey to assess freshwater invertebrates, but observations were recorded. Water temperature was measured at both sites immediately before fishing commenced, using a standard mercurial thermometer.

### 3.3 Ecological significance assessment

Westland District Plan (Section 4.9 Natural Habitats and Ecosystems) sets out eight criteria to be used to determine ecological significance under Section 6(c) of the RMA (1991). According to Policy D in Section 4.9 of the Plan, an area is significant if it meets one or more of the following criteria:

- (i) Intactness and size
- (ii) Representativeness
- (iii) Distinctiveness
- (iv) Protected status
- (v) Connectivity
- (vi) Threat
- (vii) Migratory species
- (viii) Scientific or other cultural value.

The ecological significance of the McCulloughs Creek Hydropower Project area was assessed using the eight Westland District Plan criteria. The assessment evaluated vegetation and freshwater fish only.

## 4. TOPOGRAPHY AND RAINFALL OF THE PROJECT AREA

The project area is situated in steep, mountainous terrain on the southwestern slopes of the Adams Range. McCulloughs Creek begins at approximately 1,500 metres above sea level and flows in a west to northwesterly direction down to approximately 100 metres above sea level (No.8 Ltd 2017). It then flows through gently-sloping land for approximately 1.5 kilometres to the confluence with the Whataroa River near State Highway 6. The upper reaches of McCulloughs Creek flow through a steep-sided valley, with vertical rock walls and several waterfalls (some up to five metres high).

There are several National Institute of Water and Atmosphere (NIWA) rain gauges near the project area, and according to these data the rainfall at the proposed intake site (520 metres above sea level) is estimated to be 4,900 mm per annum (No.8 Ltd 2017). More information on the topography, geology and hydrology of the project area is provided in the Environmental Impact Assessment report prepared by No.8 Ltd (2017).

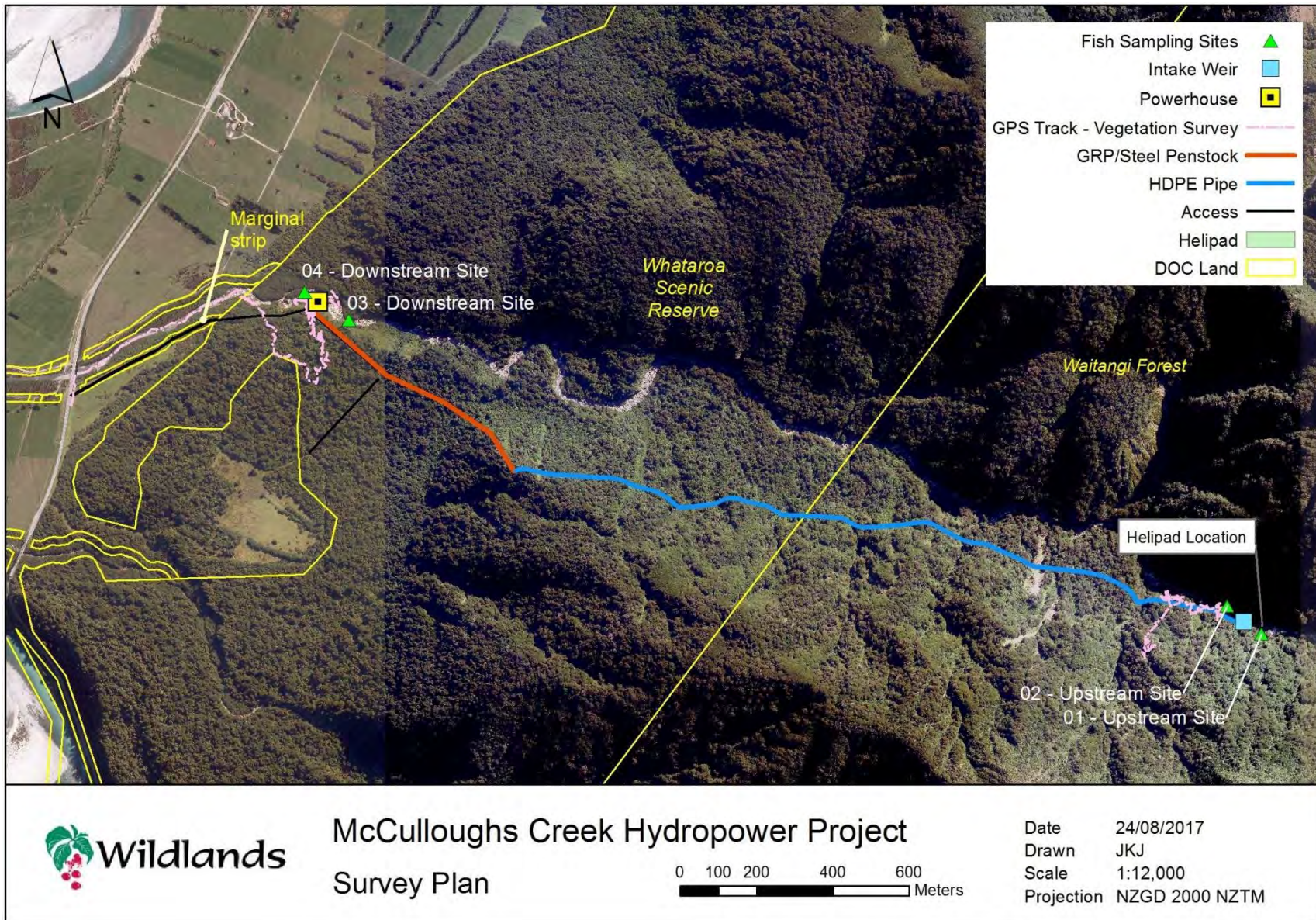

Figure 2: Location of ecological survey sites for the McCulloughs Creek Hydropower Project (map created by No.8 Ltd, August 2017).

## 5. VEGETATION

### 5.1 Overview

Vegetation in the project area consists almost entirely of indigenous forest, with five different forest types being identified during the field survey (see Table 2). Smaller areas of indigenous shrubland and grassland also occur along the Creek. Although the vegetation has not been modified by human activities, such as logging or fire, it has been adversely affected by introduced browsing mammals, particularly feral goats and possums (see comments below).

Table 2: Vegetation types observed in the McCulloughs Creek Hydropower Project area (from field survey data collected on 16 May 2017).

Survey Area	Vegetation Type (Atkinson unit)	Main Plant Species
<b>Upper Site</b>		
Helicopter landing pad	[OLEarb]-[CARarb] / CHIcon / CAREX-UNCunc grassland	<i>Olearia arborescens</i> <i>Carmichaelia arborea</i> <i>Chionochloa conspicua</i> Carex species <i>Uncinia uncinata</i>
Intake site	WEIrac / GRllit-CARser-SCHdig-COPgra / CARarb-HEBsal forest-scrub	<i>Weinmannia racemosa</i> <i>Griselinia littoralis</i> <i>Carpodetus serratus</i> <i>Schefflera digitata</i> <i>Coprosma grandifolia</i> <i>Carmichaelia arborea</i> <i>Hebe salicifolia</i> <sup>1</sup>
<b>Middle Section</b>		
Pipeline corridor	METumb / WEIrac / GRllit-SCHdig-MELram / CYAsmi / ASPbul-BLEnov forest	<i>Metrosideros umbellata</i> <i>Weinmannia racemosa</i> <i>Griselinia littoralis</i> <i>Schefflera digitata</i> <i>Melicytus ramiflorus</i> <i>Cyathea smithii</i> <i>Melicytus ramiflorus</i> <i>Asplenium bulbiferum</i> <i>Blechnum novae-zelandiae</i>
Penstock corridor	[DACcup]-[DACdac]-[PRUfer] / METumb / WEIrac-QUIser / RIPsca / CYAsmi / ASPbul forest	<i>Dacrydium cupressinum</i> <i>Dacrycarpus dacrydioides</i> <i>Prumnopitys ferruginea</i> <i>Metrosideros umbellata</i> <i>Weinmannia racemosa</i> <i>Quintinia serrata</i> <i>Ripogonum scandens</i> <i>Cyathea smithii</i> <i>Asplenium bulbiferum</i>
<b>Lower Site</b>		
Powerhouse and access road	CORarb-ARlser / SCHdig-FUCexc-HEDarb forest	<i>Coriaria arborea</i> <i>Aristolelia serrata</i> <i>Schefflera digitata</i> <i>Fuchsia excorticata</i> <i>Hedycarya arborea</i>

<sup>1</sup> Also referred to as *Veronica salicifolia*.

Brief descriptions and photographs of the vegetation types at each survey site are provided below.

## 5.2 Upper site: Intake and helicopter landing pad

The proposed helicopter landing pad site contains indigenous riparian vegetation dominated by grasses, sedges, and herbs, with occasional ferns and severely browsed tree seedlings and shrubs (Plates 1-2).

The most common species are broad-leaved bush tussock/hunangamoho (*Chionochloa conspicua*), cutty grass (*Carex* spp.), hook grass (*Uncinia uncinata*), bidibidi (*Acaena anserinifolia*), scabweed (*Raoulia tenuicaulis*), nertera (*Nertera depressa*), pratia (*Lobelia angulata*), willowherb (*Epilobium* spp.), prickly shield fern (*Polystichum vestitum*), and kiwakiwa (*Blechnum fluviatile*). Lichens such as *Stereocaulon ramulosum* were conspicuous on boulders at the site. Woody species included South Island broom (*Carmichaelia arborea*), common tree daisy (*Olearia arborescens*), New Zealand holly (*Olearia ilicifolia*), and patē/seven-finger (*Schefflera digitata*).



Plate 1: Upper survey site: indigenous riparian vegetation at the proposed helicopter landing pad site.



Plate 2: Upper survey site: the vegetation at the proposed helicopter landing pad site is dominated by indigenous grass, sedge, and herbaceous species such as broad-leaved bush tussock (*Chionochloa conspicua*), cutty grass (*Carex* spp.), bidibidi (*Acaena anserinifolia*), nertera (*Nertera depressa*), and pratia (*Lobelia angulata*).

Vegetation near the proposed water intake consists of indigenous riparian forest and scrub, which contains a diverse range of indigenous tree, shrub, fern and herbaceous species (Plate 3). The most common tree species were kāmahi (*Weinmannia racemosa*), broadleaf (*Griselinia littoralis*), marbleleaf (*Carpodetus serratus*), kanono (*Coprosma grandifolia*), shining karamū (*C. lucida*), patē, common tree daisy and three-finger (*Raukaua simplex*). Shrubs included South Island broom, koromiko (*Hebe salicifolia*), stinkwood (*Coprosma foetidissima*) and mikimiki (*C. propinqua*), while ferns included kiokio (*Blechnum novae-zelandiae*), lance fern (*B. chambersii*), smooth shield fern (*Lastreopsis glabella*) and Smith's tree fern/kātote (*Cyathea smithii*). Other common species were *Anaphalioides trinervis*, kakaha/bush lily (*Astelia fragrans*), native gunnera (*Gunnera prorepens*), bush rice grass (*Microlaena avenacea*), *Jovellana repens* and *Uncinia uncinata*. Few vascular plants occur within the waterway itself (as a result of regular flood events), but the exposed rocks and boulders are covered in a variety of moss and lichen species (Plate 4).



Plate 3: Upper survey site: indigenous forest and scrub at the proposed water intake site. A variety of tree, shrub, fern, sedge, and herbaceous species are present in the riparian zone.



Plate 4: Upper survey site: moss-covered boulders in the creek bed at the intake site.

### 5.3 Pipeline/penstock corridor

Vegetation along the pipeline and penstock corridor consists of podocarp-hardwood forest dominated by kāmahī, with southern rātā (*Metrosideros umbellata*) in the upper part (Plate 5) and emergent podocarps - kahikatea (*Dacrycarpus dacrydioides*), miro (*Prumnopitys ferruginea*) and rimu (*Dacrydium cupressinum*) - in the lower part (Plate 6).



Plate 5: Indigenous podocarp-hardwood forest in the upper section of the proposed pipeline corridor (Waitangi Forest). Ferns such as hen and chicken's fern (*Asplenium bulbiferum*) and Smith's tree fern/ kātote (*Cyathea smithii*) dominate the understorey.



Plate 6: Indigenous podocarp-hardwood forest in the lower section of the proposed penstock corridor (Whataroa Scenic Reserve). Three podocarp species are present: kahikatea (*Dacrycarpus dacrydioides*), miro (*Prumnopitys ferruginea*) and rimu (*Dacrydium cupressinum*).

This forest contains a wide range of indigenous tree, shrub, vine, fern, orchid, and non-vascular (moss, liverwort and lichen) species typical of podocarp-hardwood forests in this part of the West Coast (in 'the beech gap'). The most common tree and shrub species are broadleaf, patē, marbleleaf, māhoe (*Melicytus ramiflorus*), quintinia (*Quintinia serrata*), horopito, kanono, shining karamū, *Coprosma propinqua*, and red matipo (*Myrsine australis*). Many uprooted canopy trees were seen on the terrace in the lower section of the proposed penstock route, presumably caused by Cyclone Ita in April 2014.

Vines such as white climbing rātā (*Metrosideros diffusa*, *M. perforātā*) and bush lawyer (*Rubus cissoides*) are common throughout, while supplejack (*Ripogonum scandens*) and kiekie (*Freycinetia banksii*) are abundant in the lower section of the penstock corridor.



Both terrestrial and epiphytic ferns are abundant; common species are *Asplenium bulbiferum*, *A. flaccidum*, *A. polyodon*, *Blechnum chambersii*, *B. colensoi*, *B. discolor*, *Hymenophyllum demissum*, *H. revolutum*, *H. scabrum*, *Hypolepis* sp., *Leptopteris superba*, *Notogrammitis billiardierei* and *Rumohra adiantiformis*, as well as the tree ferns *Cyathea smithii* and *Dicksonia squarrosa*.

#### 5.4 Lower site: powerhouse and access road

The western section of the access road occurs within McCulloughs Creek Marginal Strip, where the vegetation consists mainly of introduced pasture grassland. Vegetation at the proposed powerhouse site and along the eastern section of the access road consists of indigenous riparian forest dominated by tree tutu (*Coriaria arborea*) (Plates 7-8). Secondary canopy species include patē, wineberry (*Aristotelia serrātā*), tree fuchsia/kōtukutuku (*Fuchsia excorticata*), and pigeonwood (*Hedycarya arborea*). The understorey is relatively open, as a result of periodic flood events, although it still contains a variety of indigenous plant species, including shining karamū, round-leaved coprosma (*Coprosma rotundifolia*), kaikōmako (*Pennantia corymbosa*), kiekie, hen and chicken's fern, kiokio, and *Cyathea smithii*.



Plate 7: Indigenous riparian forest dominated by tree tutu (*Coriaria arborea*) occurs at the proposed powerhouse site and along part of the access road (Whataroa Scenic Reserve).



Plate 8: Understorey of the tree tutu forest at the proposed powerhouse site is relatively open, as a result of periodic flood events (Whataroa Scenic Reserve).

## 6. FLORA

In total, 92 indigenous vascular plant species and 10 non-vascular plant species (mosses, liverworts and lichens) were recorded in the project area on 16 May 2017 (see species list in Appendix 1). None of these species are classified as nationally Threatened or At Risk according to the New Zealand Threat Classification System<sup>1</sup> (de Lange *et al.* 2013).

Only three introduced plant species were seen during the field visit:

- Catsear (*Hypochaeris radicata*): rare, upper site only.
- Gorse (*Ulex europaeus*): occasional, lower site only.
- Himalayan honeysuckle (*Leycesteria formosa*): occasional, lower site only.

<sup>1</sup> See Townsend *et al.* 2008 for an explanation.

## 7. TERRESTRIAL FAUNA

### 7.1 Avifauna

Four indigenous bird species were observed during the field visit on 16 May 2017:

- Bellbird/korimako (*Anthornis melanura*).
- Kererū (*Hemiphaga novaeseelandiae*).
- South Island fantail/piwakawaka (*Rhipidura fuliginosa fuliginosa*).
- South Island tomtit/miromiro (*Petroica macrocephala*).

None of these species are classified as Threatened or At Risk (Robertson *et al.* 2017), and are typical of indigenous forest habitat on the West Coast.

### 7.2 Introduced mammals

Feral goats (*Capra hircus*) appear to be common throughout the project area, as severe goat browse was seen on native broom (*Carmichaelia arborea*) and other palatable plant species at the upper survey site, faecal pellets were found at the intake site and along the pipeline/penstock route, and a feral goat was seen at the lower site during the field visit. Rooting by feral pigs (*Sus scrofa*) was observed along the lower section of the penstock route, particularly where canopy trees had been uprooted as a result of Cyclone Ita.

## 8. FRESHWATER ECOSYSTEM

### 8.1 Habitat character

McCulloughs Creek flows down through indigenous forest on the western side of the Adams Range, to join the braided Whataroa River that flows out into the Tasman Sea. It is a steep waterway, dominated by large boulders, cobbles and gravels, with very clear, fast-flowing water forming mostly cascades and pools (Plates 9 and 10). Information on the structure and hydrology of McCulloughs Creek, including catchment size, rainfall, water flow gauging and discharge calculations, is contained within the Environmental Impact Assessment report prepared by No.8 Ltd (2017).

The downstream survey site (Plate 9) is less steep than the upstream survey site (Plate 10), and at the time of the survey had a sluggish backwater area, roughly parallel to the Creek that appeared to have been created during previous high flow conditions.

No macrophytes were observed in the Creek during the field survey on 16 May 2017, and the riparian vegetation did not grow into the water, although some larger shrubs and trees did overhang the Creek in places. This type of waterway is typical of what would be expected on the West Coast of the South Island and is not uncommon in this region.



Plate 9: Upstream site: freshwater fish survey. Looking upstream.



Plate 10: Downstream site: freshwater fish survey. Looking downstream.

## 8.2 Fish and macroinvertebrates

Freshwater macroinvertebrates found in the downstream section of McCulloughs Creek on 14 December 2016 were all indigenous and are typical of what would be expected in this type of fast-flowing stony waterway in the forested parts of the South Island's West Coast (Table 3). In general, Threatened and/or At Risk macroinvertebrate species are more likely to be found in seepages, headwaters and small tributary systems (Brian Patrick, Wildland Consultants, pers. comm.).

Table 3: Freshwater macroinvertebrates found in McCulloughs Creek on 14 December 2016.

Family	Scientific Name	Common Name	Conservation Status (Granger <i>et al.</i> 2014)
Plecoptera	<i>Stenoperla prasina</i>	Green stonefly	Not Threatened
Plecoptera	<i>Zelandoperla fenestrātā</i>	Stonefly	Not Threatened
Plecoptera	<i>Acroperla trivacuata</i>	Stonefly	Not Threatened
Ephemeroptera	<i>Deleatidium lillii</i>	Mayfly	Not Threatened
Diptera	<i>Neocurupia tonnoiri</i>	Net-winged midge	Not assessed

Electric fishing carried out on 16 May 2017 confirmed the presence of one indigenous fish species (kōaro) at the upstream site. Two indigenous fish species (kōaro and torrentfish, Plate 11) and one introduced fish species (Plate 12) were found at the downstream site.

The number and size range of fish species caught and seen at each site are listed in Table 4, along with their conservation status.

Mayflies and stoneflies were also disturbed during electric fishing, with stoneflies being generally dominant, and macroinvertebrates more abundant at the downstream site. Water temperature was measured as 5°C at the upstream site, in the morning (09:30), and 8°C at the downstream site, in the afternoon (14:45).



Plate 11:  
Indigenous fish caught at the downstream site:  
three kōaro (*Galaxias brevipinnis*) and one  
torrentfish (*Cheimarrichthys fosteri*).



Plate 12:  
Introduced brown trout (*Salmo trutta*) caught  
at the downstream site.

Table 4: Freshwater fish found in McCulloughs Creek during the electric fishing survey on 16 May 2017.

Common Name	Scientific Name	Conservation Status (Goodman <i>et al.</i> 2014)	Number Caught	Length Range	
				Minimum (mmTL) <sup>1</sup>	Maximum (mmTL) <sup>1</sup>
<b>Upstream Site</b>					
Kōaro	<i>Galaxias brevipinnis</i>	At Risk-Declining	9	67	190
<b>Downstream Site</b>					
Kōaro	<i>Galaxias brevipinnis</i>	At Risk-Declining	27	63	147
Torrentfish	<i>Cheimarrichthys fosteri</i>	At Risk-Declining	4	92	112
Brown trout	<i>Salmo trutta</i>	Introduced and Naturalised	2	99	117

<sup>1</sup> mmTL = total length from tip of nose to end of tail.

## 9. ECOLOGICAL SIGNIFICANCE ASSESSMENT

McCulloughs Creek project area contains indigenous vegetation and habitats of indigenous fauna that are ecologically significant according to the Westland District Plan, as the following criteria are met:

- (i) Intactness and size
- (iv) Protected Status
- (v) Connectivity
- (vi) Threat
- (vii) Migratory Species
- (viii) Scientific or other Cultural Value.

See Table 5 for an explanation.

Table 5: Ecological significance assessment for the McCulloughs Creek Hydropower Project area using the significance criteria in Section 4.9 of the Westland District Plan.

Criterion	Definition	Met	Explanation
(i) Intactness	The area is unmodified by human activity, comprises a predominantly intact indigenous system and is not affected in a major way by weed or pest species; AND	<b>Yes</b> Veg Fish	The project area contains >5 ha of intact indigenous vegetation (primary-growth rātā-kāmahi and podocarp-hardwood forest) that has not been modified by human activities and is not affected by weed invasion.
Size	The area of indigenous vegetation has a predominant cover of five hectares or more.		McCulloughs Creek is a permanent waterway, with intact riparian vegetation, an unmodified channel, natural water flows, no apparent weed or elevated nutrient issues, and good quality habitat for indigenous fauna. No aquatic weed species were observed in the Creek, and although introduced predatory brown trout were found at the downstream site, the upstream site had only indigenous fish species present.
(ii) Representativeness	The area is one of the best examples of an association of species which is typical of its ecological district.	?	The area contains indigenous vegetation that is typical of the Wilberg Ecological District: rātā-kāmahi forest, podocarp-hardwood forest, and riparian forest. It is difficult to assess whether this would constitute one of the best examples in the ecological district, due to the lack of ecological information for Wilberg Ecological District.  The Creek contains freshwater fish and invertebrates that are typical of this type of fast flowing stony waterway in the forested parts of the West Coast. It is difficult to assess whether the project area is one of the best examples in the ecological district, due to the lack of information on Wilberg Ecological District.
(iii) Distinctiveness	The area has indigenous species or an association of indigenous species which is unusual or rare in the ecological district, or endemic or reaches a distribution limit in the ecological district. The area may be distinctive because of the influence of factors such as altitude, water table, soil type or geothermal activity.	No	The area does not contain any vegetation types or associations of species that are unusual or rare, either in the Wilberg Ecological District or nationally.  The area does not contain any plant or animal species at their national distribution limits.
(iv) Protected Status	The area has been set aside by New Zealand Statue or Covenant for protection and preservation or is a recognised wilderness area.	<b>Yes</b>	The area is located on protected public conservation land: <ul style="list-style-type: none"> <li>• Whataroa Scenic Reserve (769 ha)</li> <li>• Waitangi Forest Stewardship Area (57,326 ha).</li> </ul>
(v) Connectivity	The area is connected to one or more other significant areas in a way, (including through ecological processes) which makes a major contribution to the overall value or natural functioning of those areas.	<b>Yes</b> Veg Fish	The area is contiguous with extensive areas of unmodified indigenous forest, which provides habitat for wide-ranging indigenous fauna, and an important buffering function for McCulloughs Creek.  McCulloughs Creek provides an essential connection between lowland and alpine habitat for indigenous freshwater fish.

Criterion	Definition	Met	Explanation
(vi) Threat	The area supports an indigenous species or community which is threatened within the ecological district or threatened nationally.	<b>Yes</b>  Fish	No Threatened or At Risk plant species (as per de Lange <i>et al.</i> 2013) were found in the project area.  Two nationally At Risk fish species were found in McCulloughs Creek: kōaro and torrentfish (both are classified as At Risk-Declining by Goodman <i>et al.</i> 2014).
(vii) Migratory Species	An inter-tidal area or area of forest, wetland, lake, estuary or other natural habitat that is important for migratory species or for breeding, feeding or other vulnerable stages of indigenous species.	<b>Yes</b>  Fish	McCulloughs Creek is a tributary of the Whataroa River and provides important habitat for indigenous fish species that migrate within the catchment and between the freshwater and marine environments. The Creek provides essential feeding and breeding areas for fish, and a connection between lowland and alpine habitat.
(viii) Scientific or other Cultural Value	The area is a type, locality or other scientific reference area, is listed as a geopreservation site, or has a distinctive amenity value (e.g. it contributes to a distinctive and outstanding landscape of the district, has other significant cultural value or is of international importance).	<b>Yes</b>  Fish	One of the indigenous fish species found in McCulloughs Creek (torrentfish) is listed as a taonga species under the Ngāi Tahu Claims Settlement Act 1998.

## 10. PROPOSED WORKS

Proposed works comprise the construction and operation of infrastructure to produce 1,890 kW of electricity, using water from McCulloughs Creek (see Table 6 for a specification summary). The project involves taking 600 litres per second (l/s) of water from McCulloughs Creek at an upstream site and returning it to the same creek approximately three kilometres downstream (Figures 3-4). The approximate area of land to be disturbed by each component of the project is provided in Table 7, although the exact locations of the access road, cableway, pipeline, penstock, intake, powerhouse and tailrace are yet to be confirmed. No.8 Ltd intends to minimise disturbance and impacts where practical through the final design.

Table 6: Specification summary for key components in the McCulloughs Creek Hydropower Project (copied from No.8 Ltd 2017).

Description	Detail
Name	McCulloughs Creek Hydropower Project
Rated Output	1,890 kW
Rated Flow	600 l/s
Headwater Level	520 masl
Normal tailwater level	120 masl
HDPE	625 mm Ø
GRP/Steel penstocks	550 mm Ø
Gross head	400 m
Net head (Hn)	377 m
Turbine	Horizontal Pelton, 2 jet, 750 rpm
Distribution line length	~700 m

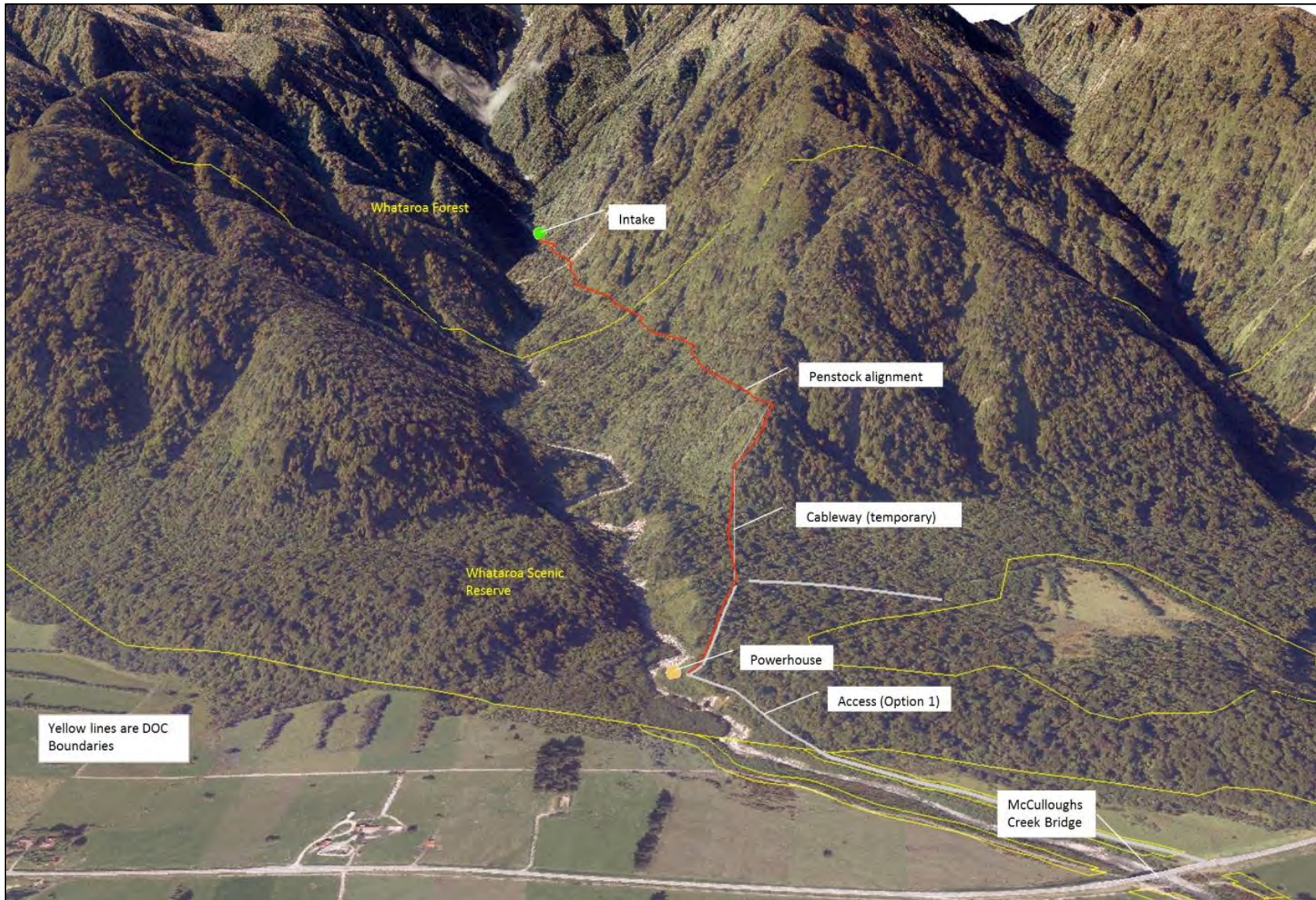

Figure 3: Overview of McCulloughs Creek and key components of the proposed hydropower project (map supplied by No.8 Ltd, August 2017).

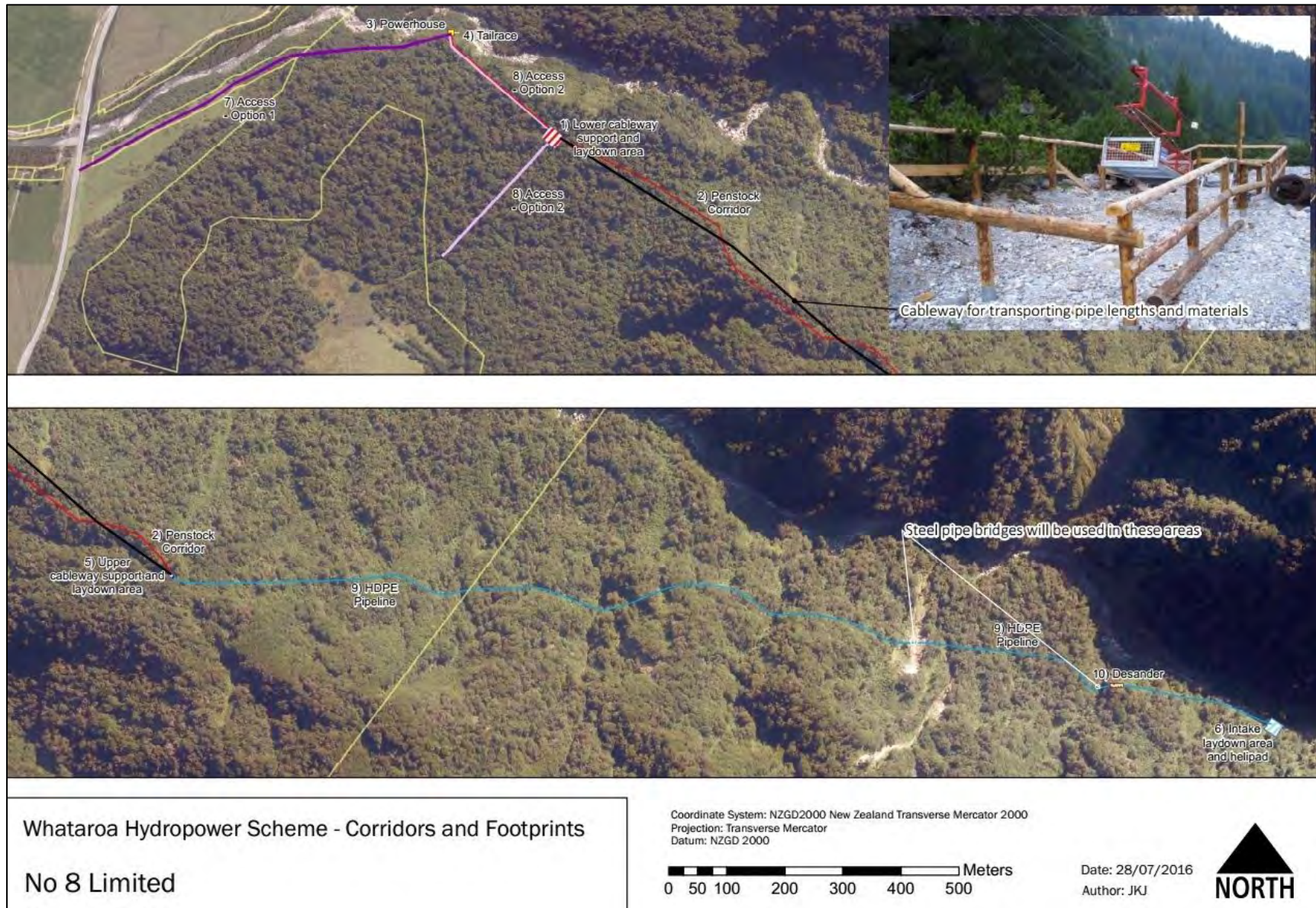

Figure 4: Corridors and footprints of components in the McCulloughs Creek Hydropower Project (map supplied by No.8 Ltd, June 2017).



Table 7: Location and area of land required for key components in the McCulloughs Creek Hydropower Project (adapted from No.8 Ltd 2017).

Component	Comments	Area in Waitangi Forest (m <sup>2</sup> )	Area in Whataroa Scenic Reserve (m <sup>2</sup> )	Area in Marginal Strip (m <sup>2</sup> )	Total (m <sup>2</sup> )
Cableway support and laydown area – Lower	Used for construction. Left to regenerate post construction.		450		450
Cableway support and laydown area – Upper	Used for construction. Left to regenerate post construction.		13		13
Desander	Approx. 12 × 2 m.	100			100
Distribution line	11 kV distribution line along road, underground cable and on wooden poles.				-
HDPE pipeline corridor and foot access	1.5 m wide corridor for 625 mm diameter penstock and foot access.	254	90		344
Intake laydown area and helipad	Approx. 10 × 20 m. Left to regenerate post construction.	219			219
Lookout	2 × 5 m with timber bench.				
Penstock corridor and foot access	1.5 metre wide corridor for penstock and foot access.		2,028		2,028
Penstock GRP/Steel	550 mm tapering to 475 mm diameter, 910 m long.				-
Penstock HDPE	625 mm diameter, 1,840 m long.				-
Powerhouse	7 × 6 m Coloursteel garage on a 10 × 10 m fenced area.		75		75
Tailrace	2 m wide corridor, 10 m long. Tailrace channel is 0.75 m wide.		20		20
Vehicle access to powerhouse	2.5 m wide unsealed, gravel access track.		652	1,082	1,733
<b>Total</b>		<b>572</b>	<b>3,327</b>	<b>1,082</b>	<b>4,981</b>

Detailed information on the proposed works is provided in the Environmental Impact Assessment report prepared by No.8 Ltd (2017). A brief summary of the key components in the project is provided below:

- Installation of a water flow and gauging station for McCulloughs Creek.
- A permanent unsealed **vehicle access road**, approximately two metres wide, will be constructed from State Highway 6, across pastoral farmland and through indigenous forest to the powerhouse (Figure 4). This road would be similar to a basic farm access track and would be constructed to avoid canopy trees with a diameter at breast height (dbh) of greater than 30 cm. The traffic on this road would comprise an occasional vehicle to check on and maintain the unmanned powerhouse, as needed.
- A temporary **aerial cableway** (see inset on Figure 4) will be constructed through the forest from the powerhouse up to the intake (c.1.7 km). This will be used to carry construction materials and equipment along the pipeline/penstock alignment and up to the intake site. The width of the construction access clearing will be 1.5 to 2.0 metres. Construction of the supporting towers and thrust blocks will require vegetation

clearance, however canopy vegetation will be avoided as much as possible. The lattice trusses will be 5-10 metres tall and will be supported by guy ropes attached to trees and dead-man anchors. A number of intermediate supports will also be installed, to guide the cable along the penstock alignment and allow for changes in slope and direction. The intermediate supports will be secured to trees and rock anchors. Once construction is complete the cableway will be removed and indigenous vegetation will be left to regenerate, although the route of the penstock will be maintained clear of vegetation (approximately 0.75 metres wide) to allow foot traffic (see below).

- A permanent **foot access track**, approximately 0.75 metres wide, will be created along the pipeline and penstock alignment from the powerhouse up to the intake. It will be used during construction and ongoing operation and maintenance of the infrastructure. It will also provide public access to Whataroa Scenic Reserve and Waitangi Forest. This access track will be similar to a typical tramping track (Department of Conservation 2017) and be constructed under the forest canopy. Understorey vegetation would be removed to construct the track and pipeline/penstock, but this would be allowed to regenerate post-construction. This track would facilitate access for pest animal and weed control, in addition to ongoing ecological monitoring of the area in general.
- **Construction laydown areas** will be created at the cableway supports and intake site. This will require the clearance of 100 m<sup>2</sup> of non-canopy vegetation at the lower site and 50 m<sup>2</sup> at the upper site. At the intake site, the laydown area to be cleared will be approximately 219 m<sup>2</sup> and incorporate a **helicopter landing and take-off pad**. The proposed helicopter pad and staging area, 30 metres upstream of the intake, will allow access to the intake and upper penstock location. A cable line from the helicopter pad to the intake site will allow safe transport of materials and equipment, and facilitate heavy lifting without heavy equipment. If required for specific tasks, a small compact excavator would be flown in by helicopter. If used, machinery would be sealed and maintained to ensure that oils, fuels, greases and lubricants cannot spill into the river or surroundings.
- A concrete and steel **intake system** will be installed in the bed of the Creek, at about 520 metres above sea level (see Figure 5). No.8 Ltd proposes to use a Coanda style intake screen and weir, but the dimensions of this, including the width of creek affected, have not yet been confirmed. This type of system sits in the waterway, keyed into the substrate, and has been developed for use in steep alpine waterways. The general design is for water to flow over the intake screen, with a proportion of it flowing through the grill and down into a pipeline to travel to the powerhouse. The intake is designed for a discharge of 600 litres per second (l/s) through a 2.4 metre-wide Coanda screen. This discharge is associated with an upstream water level of 0.3 metres above the Coanda crest. An additional outlet will be provided to allow water to flow over rock banks at the downstream face of the structure, allowing fish to pass upstream and downstream of the weir even during low flows. The weir is designed to pass the 100-year flood level, which is estimated to be 15,000 l/s (15 m<sup>3</sup>/s). Flood discharge would pass over the weir, via a 14 metre-long overflow section. Under the design 100-year flood of 15,000 l/s the weir will pass the discharge with an estimated upstream water level of 0.6 metres over the crest. Concrete abutments will be constructed at each end of the weir structure, to anchor it into the rock banks 0.5 to 1.0 metres above the water level. Total estimated length of the weir will be 16 metres, from left abutment to right abutment. The intake screen will be constructed with 1.0 mm bar

spacing, to provide protection for fish entrainment and exclusion of coarse sediment and bedload. The section of pipeline in the Creek will be encased in concrete to protect it from moving bedload.

- A temporary water diversion will be created, to enable installation of the intake and associated pipe in a dry works zone.



Figure 5: Overview of the works at the proposed intake site on McCulloughs Creek (supplied by No.8 Ltd, 16 August 2017).

- A **desander** will be constructed on the bank of the Creek, downstream of the intake structure (Figure 4). This will remove sediment so that it does not flow into the pipeline/penstock and powerhouse, and will enable flushing flows to return sediment to the Creek via a natural watercourse along the Creek banks. The desander will be connected to the intake structure by a 625 mm diameter pipeline, and will have an outlet to the Creek and an emergency spillway.
- A 625 mm diameter **high-density polyethylene (HDPE) pipeline** will take water from the desander to the penstock and powerhouse (Figures 3-4). It will be constructed so that it mostly lies along the ground surface and will be anchored at various points, with stakes and concrete anchors. At any point where it spans a waterway, a pipe bridge will be constructed and this will be anchored on both banks. Sections of pipeline will be lifted in to laydown areas, via the cableway, and then pulled along the ground's surface. The pipe lengths will be welded together on-site and can then be pulled as a long string with winches.
- The **penstock** will be constructed above ground and will be anchored with stakes and concrete anchors. The lower penstock will be installed on concrete supports, and will consist of 550 mm diameter glass fibre reinforced plastic (GRP) pipe, tapering to 475 mm diameter steel pipe at the powerhouse. Where the penstock spans a waterway, a pipe bridge will be constructed, with steel pipe, and anchored on both banks. In areas where the penstock crosses the alpine fault it will have appropriate joining and support, and consideration for drainage paths in the event of fault movement causing penstock

rupture. The proposed width of the penstock footprint is 2.0 metres during construction and 1.5 metres during operation. The penstock supports are spaced at 12 metre centres and the supports and thrust blocks are 750 mm wide. Sections of penstock will be lifted in to laydown areas, via the cableway, and then pulled along the ground's surface.

- A **powerhouse** (measuring approximately 7 × 6 metres) will be constructed at c.120 metres above sea level. This will be built beside the Creek, on solid foundations, approximately 5-10 metres above the normal water level and above the 100-year flood return period level, so as to reduce flood damage risk. A **transformer** will be built adjacent to the powerhouse and this will feed an 11 kV line to connect the scheme to the Westpower network. The powerline will be buried in a conduit beside the access road until it reaches the marginal strip where it will be installed on poles to interface with the Westpower system.
- A **tailrace** will be constructed to enable water to flow out of the powerhouse and back into McCulloughs Creek. This will be a concrete channel that will be elevated above the Creek level, to allow water to flow over a drop and into the Creek. Riprap will be placed below the channel outlet (reviewed by a suitably qualified person before being approved for construction) to reduce the risk of scour and erosion.
- A **foot access track** will run along the penstock alignment climbing up to a summit (at approx. 400 metres above sea level) and a **lookout area** established along an additional 1.7 kilometres of track traversing the valley to the proposed intake site. This will enable easier access into Whataroa Scenic Reserve and Waitangi Forest for pest animal and weed control, ecological monitoring, and public enjoyment.
- A **lookout** area will be established in Whataroa Scenic Reserve at the summit (approximately 400 metres asl) of the permanent foot access track that runs along the penstock alignment.

## 11. ASSESSMENT OF POTENTIAL EFFECTS

### 11.1 Vegetation

#### 11.1.1 Construction effects

- Construction of the helicopter landing pad will cause disturbance to indigenous vegetation within its 219 m<sup>2</sup> footprint. Although vegetation does not need to be cleared for the landing pad (as the structure will be erected on top of the vegetation), the loss of some indigenous plants (mostly sedges, rushes, and herbs) is likely. The area that will be affected is relatively small, however, and the vegetation has good potential to recover post-construction (see comment below in the operational effects section), therefore construction of the landing pad is expected to have a *minor adverse effect* on indigenous vegetation.
- Construction of the water intake structure will result in damage to some indigenous riparian vegetation adjacent to the waterway, however this will affect a relatively small area, and is considered to be a *less than minor adverse effect*.

- Construction of the access road and powerhouse will result in the destruction of 1,082 m<sup>2</sup> of vegetation in McCulloughs Creek Marginal Strip and 652 m<sup>2</sup> of vegetation in Whataroa Scenic Reserve (1,733 m<sup>2</sup> or 0.1733 ha in total). This represents <0.001% of the total area of indigenous forest (27,345 ha) in the Wilberg Ecological District. Most of the vegetation in the Marginal Strip is modified pasture grassland, and the clearance of a small area of indigenous forest at the eastern end of the Marginal Strip will have a *minor adverse effect* on indigenous vegetation. A corridor of indigenous forest - approximately 200 metres long and 2.5 metres wide - will be cleared in Whataroa Scenic Reserve, however the road will be located along the edge of the Reserve and pass through riparian tutu forest, which is subject to regular natural disturbance through flooding. Overall, construction of the road is expected to have a *minor adverse effect* on indigenous vegetation in the Reserve.
- Construction of the cableway, foot access track, pipeline, penstock, and desander will require clearance of approximately 2,935 m<sup>2</sup> of indigenous forest along a two metre-wide corridor. This represents 0.001% of the total area of indigenous forest (27,345 hectares) in the Wilberg Ecological District. If canopy trees are cleared and substantial gaps are opened up in the canopy this will have a *significant adverse effect* on indigenous vegetation. As well as the direct loss of vegetation within the corridor, this would result in fragmentation of the forest along the corridor, leading to “edge effects”. Edge effects include increased light, temperature and nutrient levels and lower relative humidity (Murcia 1995). These abiotic changes have the potential to alter indigenous plant species composition (e.g. death of subcanopy and understorey species that require shade) and facilitate invasion by introduced plants (Malcolm 1994). Creating gaps in the forest canopy would also make the adjacent forest more vulnerable to windthrow in storm events, thereby increasing the total area of forest that is disturbed.
- Construction of the access road, pipeline and penstock will produce substantial amounts of cleared material (rocks, soil and vegetation) that must be disposed of. Inappropriate disposal of this material (e.g. dumping it on indigenous vegetation outside the corridor) could greatly increase the size of the designated construction footprints and result in *more than minor adverse effects* on indigenous vegetation.
- The applicant intends to minimise damage to canopy vegetation during construction of the cableway, pipeline and penstock, and foot access track by avoiding destruction of trees >30 cm dbh as much as possible. If the cableway and pipeline/penstock can be installed without noticeable canopy gaps being created, and the measures to avoid and minimise adverse effects in Section 12 are implemented, then potential adverse effects on indigenous vegetation along the corridor can potentially be reduced to *minor*.
- Introduced weeds could be introduced to the project area through access by people, vehicles, equipment and construction materials (particularly stones and gravels) carrying weed propagules (seeds and/or fragments). In the long-term, this has the potential to have a *more than minor adverse effect* on indigenous vegetation, depending on which weed species were introduced and whether they were allowed to spread. The introduction of weeds is particularly a concern for the upper site (helicopter landing pad and intake), as the upper section of McCulloughs Creek appeared to be almost completely free of introduced plants (at the time of the field survey in May 2017).

- Access by introduced pest mammals such as feral goats and pigs could be facilitated by clearance of vegetation along the pipeline/penstock corridor, as pest animals will often utilise such tracks for movement. However, this effect is considered to be *less than minor*, as pest mammals are already present throughout the project area and are having adverse effects on indigenous vegetation.
- Construction activities could increase the risk of a fire in the project area, e.g. sparks from welding and chainsaws, fuel spills, and helicopter activity. However, because of the cool, wet climate, the vegetation in the project area is not particularly susceptible to fire, and it is likely that any fire would not spread rapidly or affect a large area. Subject to appropriate management, potential adverse effects on indigenous vegetation from fire are therefore likely to be *minor*.

### 11.1.2 Operational effects

- Once construction is finished, the cableway will be removed and indigenous vegetation will be allowed to regenerate along the pipeline and penstock corridor. However, maintenance of the pipeline, penstock, and foot access track will require ongoing clearance of indigenous understorey plants that regenerate within the corridor (approximately 0.75 metres wide). Clearance of any tree falls that affect the pipeline/penstock corridor will also be required, particularly after storm events. Provided that the forest canopy is not disturbed and additional understorey vegetation is not damaged by maintenance of the infrastructure (i.e. the effects will be similar to those from maintenance of a typical tramping track), this is considered to have a *minor adverse effect* on indigenous vegetation.
- Operation of the desander involves sediment-laden water being discharged back into the Creek via a small watercourse in the forest. This is expected to have a *less than minor effect* on indigenous vegetation, provided that it does not lead to increased erosion.
- The applicant intends to remove the helicopter landing pad after the intake structure and pipeline has been installed, in order to allow indigenous vegetation to regenerate. Indigenous plants would be expected to naturally re-colonise the disturbed area over time, as there is an ample seed source of suitable species surrounding the site. Provided that introduced weeds are not allowed to invade the disturbed area following removal of the helipad, then the temporary use of the landing pad is expected to have a *less than minor adverse effect* on indigenous vegetation in the long-term.
- The introduction of the foot access track will lead to increased human activity in the project area, which could have both positive and negative effects on indigenous vegetation. The track will allow easier foot access into the upper part of McCulloughs Creek, which will facilitate conservation management, such as pest control, however there is also increased potential for weeds, pathogens, rubbish, and other contaminants to enter this relatively pristine area.

## 11.2 Freshwater habitat, fish and macroinvertebrates

### 11.2.1 Construction effects

During construction of the proposed hydropower infrastructure there will be activities that could potentially adversely affect the freshwater ecosystem. It would be expected that these effects would only last for a short time and could include the following:

- Potential for sediment and/or other contaminants (e.g. fuels, oils, cement, hydraulic fluids) to enter the Creek, and directly and indirectly kill freshwater fish and invertebrates. Depending on the duration and frequency of contaminants entering the waterway, this could have adverse effects ranging from *less than minor to more than minor*. These potential effects can be avoided.
- Disturbance/damage of the substrate and banks can disrupt fish migration activities, crush freshwater plants and animals, including their eggs and larvae, and reduce habitat availability by destroying its structure and/or increasing sedimentation. Depending on the duration, frequency and timing of such disturbance this could have adverse effects ranging from *less than minor to more than minor*.
- Works carried out in flowing water can directly kill freshwater organisms, cause increased sedimentation, inhibit fish passage, trap fish, disrupt migration and spawning activities, and kill fish eggs and larvae. Depending on the duration, frequency and timing of such works this could have adverse effects ranging from *less than minor to more than minor*.
- Machinery, and other equipment, brought into the construction site could inadvertently carry plant material (including seeds, and eggs from invertebrates and fish) from species not naturally occurring at the site, leading to future pest plant and pest animal issues. Depending on the invasiveness of the species introduced this could have adverse effects ranging from *less than minor to more than minor*.

### 11.2.2 Operational effects

During operation of the proposed hydropower infrastructure there will be activities that could adversely affect the freshwater ecosystem. These activities could have effects that will occur during the entire lifetime of the project, and possibly beyond its lifetime, and include the following:

- Contaminants (e.g. fuels, oils, cement, sewage) entering the Creek can directly and indirectly kill freshwater organisms. Depending on the duration and frequency of contaminants entering the Creek, this could have adverse effects ranging from *less than minor to more than minor*.
- Sediment movement and deposition changes can affect aquatic organisms by causing structural habitat changes within the Creek. It is proposed that sand and small gravels entering the intake will be removed from the waterway into a desander and then flushed from there back into the Creek at a localised point. Because they will be discharged into the area between the intake site and the powerhouse outlet, where the water flow is reduced, they may accumulate and alter habitat there, potentially changing fish and invertebrate populations. Sediment levels that are elevated in the

Creek, e.g. during maintenance works, can smother freshwater organisms, clog their gills and alter food availability. Depending on the duration and frequency of sedimentation changes, this could have adverse effects ranging from *less than minor to more than minor*.

- Upstream and downstream fish passage could be blocked or inhibited by structures built in the Creek. Note that the species recorded in McCulloughs Creek must travel between the marine and freshwater environments to complete their lifecycle. Blockage or inhibition of fish passage could have *significant adverse effects*, and would contravene the Freshwater Fisheries Regulations 1983.
- The water intake structure/s could directly injure or kill fish if they get drawn into the mechanism. Depending on the number of fish drawn into the system this could have *adverse effects ranging from minor to significant*.
- Removal of water from the Creek will increase the number of low flow days per year, when the Creek is at the mean annual low flow level (MALF), along the three kilometre reach between the intake site and powerhouse outlet, reducing habitat availability for freshwater organisms. It could also cause: loss of connectivity between upstream and downstream areas, changes in availability of food and nutrients, water quality changes (e.g. increased temperature and reduced dissolved oxygen), structural habitat changes through altered movement of sediments and other material, changes in the water flow regime (particularly natural fluctuations in flow), fish and invertebrate community changes, reduced respiration and egg aeration, altered fish migration triggers, and increased algal growth (Beca 2008). No.8 Ltd (2017) state, in their environmental impact assessment report, that estimated low flow (MALF) duration will increase from less than 5% of the time to over 50% of the time. Depending on the actual increased frequency of low flow days and overall relative amount of water removed this could have *adverse effects ranging from minor to significant*.
- Discharge of water from the tailrace, desander, and any other spillways could cause erosion of the waterway and/or its banks, altering habitat, and could attract fish to enter the pipes. Depending on changes to the waterway structure/function and the proportion of fish attracted into the system, this could have *adverse effects ranging from minor to significant*.
- Machinery and other equipment brought in for maintenance works could inadvertently carry plant material (including seeds, and eggs from invertebrates and fish) from species not naturally occurring at the site, leading to future pest plant and pest animal issues. Depending on the invasiveness of the species introduced this could have *adverse effects ranging from less than minor to more than minor*.



## 12. MEASURES TO AVOID, REMEDY, AND/OR MITIGATE POTENTIAL ADVERSE EFFECTS

### 12.1 Vegetation

The following measures should be implemented in order to avoid and/or minimise potential adverse effects on significant indigenous vegetation from construction and operation of the proposed hydropower project. In addition, appropriate mitigation measures should be implemented to mitigate adverse effects on indigenous vegetation that cannot be avoided or remedied.

#### 12.1.1 Construction phase

- In order to avoid significant adverse effects on indigenous vegetation from construction of the proposed hydropower scheme it is essential that appropriate low-impact construction methods are used and that the construction phase is carefully planned and supervised.
- Destruction of and disturbance to indigenous vegetation during construction of the access road, pipeline/penstock, powerhouse and helicopter landing pad must be minimised by keeping the construction footprints as small as possible. Mechanical excavation (with a digger) should not be used for construction of the pipeline and penstock corridor, except where lower-impact methods (e.g. manual clearance with chainsaws and hand tools) are not possible or practical. Most of the pipeline and penstock route is very steep, and excavated materials (rocks, soil, vegetation) must be contained, by the use of appropriate tree felling methods, barriers and fences, and carefully disposed of during construction in order to ensure that debris does not fall downslope onto adjacent vegetation or end up in McCulloughs Creek.
- Damage to large canopy trees (>30 cm dbh) must be avoided as much as possible, in order to reduce 'edge effects' on adjacent forest and the potential for windthrow.
- A suitably qualified and experienced ecologist must be involved in the selection of the route of the access road and pipeline/penstock corridor in order to identify indigenous plants that should be avoided and ensure that the proposed infrastructure has the least impact on significant indigenous vegetation and fauna. This selection process would involve on-site surveying and marking of trees. An ecologist should also be involved in monitoring the effects of construction on indigenous vegetation, e.g. measuring canopy cover before and after construction.
- The amount of gravel and artificial building materials (concrete, steel, timber, plastic) brought in for construction should be minimised as much as possible, particularly at the upper site (intake and helicopter landing pad) and along the pipeline corridor. For example, existing gravel and rock from McCulloughs Creek (non-flowing areas) should be used for construction of the intake and helicopter landing pad, instead of bringing in gravel from external sources. Excess and waste materials should be removed from the project area.
- The introduction of weed propagules (seeds and/or plant fragments) to the project area must be minimised as much as possible, in order to reduce the risk of weed invasion. Vehicles, equipment, and materials entering the project area should be sourced

carefully and inspected and cleaned thoroughly beforehand to ensure that they are not carrying weed propagules. All contractors working on site should be aware of the relevant biosecurity protocols.

- Monitoring for introduced weeds should be carried out during the construction phase by a suitably qualified and experienced person. Key sites for weed monitoring are: the access road, landing pad, intake site, and pipeline/penstock corridor. If required, weed control should be implemented in a timely manner by a suitably trained person using the most appropriate methods, i.e. methods that avoid adverse effects on indigenous vegetation and fauna.
- A fire management plan should be prepared for the project, in order to minimise the potential risk and effects of a fire during construction and operation of the scheme.

### 12.1.2 Operational phase

- Disturbance to indigenous vegetation during operation and maintenance of the pipeline, penstock and other infrastructure must be kept to a minimum. Indigenous vegetation should be allowed to regenerate as much as possible, and forest canopy cover should be retained as much as possible, i.e. no canopy gaps created through tree clearance. Low-impact methods must be used for maintenance of the infrastructure (i.e. manual clearance of vegetation with hand tools and chainsaws, not mechanical excavation), and maintenance should be similar to that required for a typical tramping track.
- Ongoing monitoring of introduced weeds should be carried out in the project area by a suitably qualified and experienced person. Key sites for monitoring are: the intake site, powerhouse, pipeline/penstock corridor, and access road. If necessary, control of weeds should be implemented in a timely manner by a suitably trained person using the most appropriate methods, i.e. methods that avoid adverse effects on indigenous vegetation and fauna.
- Control of pest mammals (particularly feral goats) in the project area, and/or nearby conservation land, would help to mitigate residual adverse effects on indigenous vegetation that cannot be avoided. An appropriate pest control programme (i.e. encompassing a sufficient area, hunting effort, and duration to provide adequate mitigation) should be developed in consultation with suitably qualified professionals and the Department of Conservation.
- Restoration planting is not required following removal of the helicopter landing pad structure. Instead, the site should be left to regenerate naturally from local seed sources, as this will ensure that ecologically inappropriate species are not introduced to the project area.

## 12.2 Freshwater habitat, fish and macroinvertebrates

### 12.2.1 Construction phase

It would be expected that, due to the short-term nature of the proposed construction activity, potential adverse effects could be adequately avoided or mitigated by the following actions:

- An appropriate Erosion and Sediment Control Plan needs to be developed and implemented.
- No contaminants - including, but not limited to, fuels, oils, cement, hydraulic fluids - shall be released into or near the water from equipment being used for the works. No machinery or equipment shall be cleaned, stored or refuelled within 10 metres of the Creek and all machinery shall be well maintained at all times to prevent leakage or spill of oil or other chemicals into the Creek. A response plan may be required to address containment of any spills.
- Works should be carried out so as to cause minimal disturbance to the waterway banks and substrate, with access/movement of vehicles or other machinery in the waterway kept to a minimum. Any damage/erosion that is attributable to the works is to be repaired.
- Construction of any structure within the Creek should be carried out in dry areas of the waterway. If this requires water to be temporarily diverted and area/s of the Creek to be dewatered, then fish will need to be actively salvaged and relocated from the dewatered area into clear water well away from the works area, and appropriate bunds/fences installed to prevent water and fish re-entering the dewatered area.
- Works, and associated temporary structures, shall be undertaken in such a manner that will provide for fish passage. Any fish trapped by the works shall be immediately relocated into clear water, well away from the works area.
- As far as is practicable, in-stream works will not be carried out during key fish spawning and migration periods (Appendix 2).
- All machinery and other equipment shall be cleaned before and after use at a site, using standard biosecurity protocols such as those developed by the Ministry of Primary Industries (Check, Clean, Dry) [www.biosecurity.govt.nz/cleaning](http://www.biosecurity.govt.nz/cleaning).

### 12.2.2 Operational phase

Operational effects of the proposed works will be much longer-term than construction effects and the following procedures are suggested to help avoid and/or mitigate these:

- An appropriate Erosion and Sediment Control Plan needs to be implemented, particularly during any maintenance works.
- As far as is practicable, in-stream works required for maintenance of the proposed infrastructure will not be carried out during key fish spawning and migration periods (Appendix 2).
- No contaminants (e.g. fuels, oils, cement, hydraulic fluids) shall be released into or near the water from equipment and infrastructure being used for electricity production, or the maintenance of such. No machinery or equipment shall be cleaned, stored or refuelled within 10 metres of the Creek and all machinery shall be well maintained at all times to prevent leakage or spill of oil or other chemicals into the Creek. A response plan may be required to address containment of any spills.

- As far as is practicable, discharge of sediments and other material from the proposed infrastructure is to be managed to resemble normal conditions of duration, frequency, and volume.
- Any structures built in the waterway must be designed to enable fish passage, both upstream and downstream, at all times.
- Design and function of the intake structure and associated elements should be in keeping with the seven key principles of good practice for surface water intakes covering: intake location, approach velocity, sweep velocity, fish bypass design at screen, fish bypass design for connectivity, screening materials (mesh size), and operations & maintenance (Jamieson *et al.* 2007). The water intake structure must not take up the whole width of the Creek, calculated as wetted width during mean annual low flow (MALF), to ensure that fish can get access past the structure and do not have to swim over it.
- Water abstraction rates should be consistent with the Proposed National Environmental Standard on Ecological Flows and Water Levels (MfE 2008) and the National Policy Statement for Freshwater Management (MfE 2014). Natural fluctuations in water flow and discharge need to be able to occur and water abstraction should cease when the water level is at mean annual low flow (so that the water level in the Creek is never reduced to less than 100% of MALF). The proposed increase in duration of low flows from 5% to 50% is substantial and it is important that this is not allowed to increase beyond that.
- The tailrace, desander, and other discharge areas need to be designed to prevent fish access and should be armoured in such a way as to prevent erosion/scour of the waterway and its banks. Such erosion/scour protection works need to be designed to provide suitable physical habitat structure, e.g. matching the naturally existing habitat, and the design plans should be reviewed by a suitably qualified person before being approved for construction.
- All machinery and other equipment shall be cleaned before and after use at a site, using standard biosecurity protocols such as those developed by the Ministry of Primary Industries (Check, Clean, Dry) [www.biosecurity.govt.nz/cleaning](http://www.biosecurity.govt.nz/cleaning).

Installation of a permanent water flow and gauging station for McCulloughs Creek, in conjunction with NIWA, is discussed in the Environmental Impact Assessment report for the project (No.8 Ltd 2017). Data collected from this will enable more accurate hydrological monitoring and flow calculations to be carried out. This information can then be used to assist with setting water abstraction limits and cessation triggers, and ongoing management of operations to minimise adverse effects on the freshwater ecosystem.

Freshwater ecosystem monitoring would be advisable, to determine whether the proposed activity is having ongoing adverse effects, although it would need to be linked to potential remedial actions and when they would be instigated in order to prevent further harm and to restore natural functioning of the Creek. Such monitoring would need to be carried out by suitably qualified and experienced people, both above and below the proposed intake site, and could include the following: water depth, wetted width, dissolved oxygen, temperature, periphyton cover, macroinvertebrates and fish. Baseline monitoring would need to occur before the proposed works are initiated, and the timing of ongoing monitoring would need to take into account seasonal fluctuations.

## 13. CONCLUSIONS

The McCulloughs Creek Hydropower Project area contains ecologically significant indigenous vegetation and freshwater habitats that have not been modified to any degree by human activities. Construction and operation of the proposed hydropower project will have temporary and permanent adverse effects on indigenous vegetation and freshwater habitats and fauna that could range, without mitigation, from *less than minor to significant*. If the measures proposed in Section 12 are implemented, adverse effects are likely to be reduced to *minor or less than minor*.

Clearance of indigenous vegetation for the access road and pipeline/penstock corridor cannot be avoided. However, potential adverse effects on indigenous vegetation can be minimised by careful planning and implementation of a number of measures, in consultation with a suitably qualified and experienced ecologist. It is essential that construction footprints are kept as small as possible (e.g. by keeping mechanical excavation to a minimum) and that the construction phase is carefully supervised. Potential mitigation for residual adverse effects on indigenous vegetation includes pest mammal control, carried out at an appropriate scale, frequency, and duration.

Freshwater ecosystems involve complex interactions between the water volume and velocity, sediment and substrate, nutrients, plants, and animals. Activities during the construction phase of the project are expected to only last for a relatively short time, and if appropriate measures are adopted it would be expected that adverse effects on the freshwater ecosystem from these activities will be *less than minor*. However, adverse effects on the freshwater ecosystem will continue during operation of the project, and could continue beyond the lifetime of the project. If the proposed measures are followed, almost all of the operational effects of the project (e.g. inhibition of fish passage) can be adequately avoided or mitigated, reducing their adverse effects to *no more than minor*.

The key adverse freshwater habitat effect that will be difficult to adequately mitigate is water abstraction, and consequent reduction in flow levels and volumes for approximately three kilometres of the Creek. Removal of water from the Creek will have many inter-related outcomes that could directly and indirectly adversely affect fish and invertebrate communities at a *more than minor* level. Flow gauging and ecological monitoring will help to assess these ongoing effects, and must be linked to remedial actions and triggers for their instigation. This will help to prevent further harm and reinstate adequate natural functioning of the freshwater ecosystem, thus ensuring ongoing adverse effects are *no more than minor*. It will also be important to ensure that there is no additional water abstraction in the future, within or upstream of the project area, that will further reduce water levels.

## ACKNOWLEDGEMENTS

We thank Jeremy Kent-Johnston and Fergus Cleaver (both from No.8 Ltd) for arranging helicopter access to the intake site and for their excellent assistance during the field survey.

## REFERENCES

- Atkinson I.A.E. 1985: Derivation of vegetation mapping units for an ecological survey of Tongariro National Park. *New Zealand Journal of Botany* 23: 361-378.
- Beca 2008: *Draft guidelines for the selection of methods to determine ecological flows and water levels*. Report prepared by Beca Infrastructure Ltd for the Ministry for the Environment, Wellington. Available online at: <http://www.mfe.govt.nz/sites/default/files/draft-guidelines-ecological-flows-mar08.pdf>.
- Charteris S.J. 2006: *Native fish requirements for water intakes in Canterbury*. Department of Conservation, Christchurch.
- de Lange P.J., Rolfe J.R., Champion P.D., Courtney S.P., Heenan P.B., Barkla J.W., Cameron E.K., Norton D.A., and Hitchmough R.A. 2013: Conservation status of New Zealand vascular plants, 2012. *New Zealand Threat Classification Series* 3. Department of Conservation, Wellington. 70 pp.
- Department of Conservation 2010: West Coast *Te Tai o Poutini* Conservation Management Strategy 2010-2020 Volume I. West Coast *Tai Poutini* Conservancy Management Planning Series no. 10. Department of Conservation, West Coast Conservancy, Hokitika. 428 pp.
- Department of Conservation 2017: Walking track categories. Department of Conservation website, accessed 12 September 2017. See <http://www.doc.govt.nz/parks-and-recreation/things-to-do/walking-and-tramping/track-categories/>
- Goodman J.M., Dunn N.R., Ravenscroft P.J., Allibone R.M., Boubée J.A.T., David B.O., Griffiths M., Ling N., Hitchmough R.A. and Rolfe J.R. 2014: Conservation status of New Zealand freshwater fish, 2013. *New Zealand Threat Classification Series* 7. Department of Conservation, Wellington. 12 pp.
- Grainger N., Collier K., Hitchmough R., Harding J., Smith B. and Sutherland D. 2014: Conservation status of New Zealand freshwater invertebrates, 2013. *New Zealand Threat Classification Series* 8. Department of Conservation, Wellington. 28 pp.
- Jamieson D., Bonnett M., Jellyman D., and Unwin M. 2007: Fish Screening: good practice guidelines for Canterbury. *NIWA Client Report: CHC2007-09*. NIWA Project: INZ006501.
- Landcare Research 2015: Land Cover Database version 4.1 (LCDB v4.1). Available at: <https://iris.scinfo.org.nz/layer/48423-lcdb-v41-land-cover-database-version-41-mainland-new-zealand/>.
- Malcolm J.R. 1994: Edge effects in Central Amazonian forest fragments. *Ecology* 75: 2438-2445.
- McDowall R.M. 1990: *New Zealand Freshwater Fishes - A natural history and guide*. Heinemann Reed, MAF Publishing Group, Wellington, New Zealand.
- McDowall R.M. 2000: *The Reed Guide to New Zealand Freshwater Fishes*. Reed Books, Auckland, New Zealand.

- McEwen W.M. 1987: *Ecological Regions and Districts of New Zealand*. Third revised edition in four 1:500,000 maps. Booklet to accompany Sheet 4: descriptions of districts in the southern South Island; also southern islands not shown on map. *Publication No. 5 (in four parts). Part 4*. New Zealand Biological Resources Centre, Department of Conservation, Wellington.
- Ministry for the Environment (MfE) 2008: Proposed National Environmental Standard on Ecological Flows and Water Levels. Ministry for the Environment, Wellington. Available at: <http://www.mfe.govt.nz/fresh-water/national-environmental-standards>
- Ministry for the Environment (MfE) 2014: National Policy Statement for Freshwater Management. Ministry for the Environment, Wellington. Available at: <http://www.mfe.govt.nz/fresh-water/national-policy-statement>.
- Murcia C. 1995: Edge effects in fragmented forests: implications for conservation. *Trends in Ecology and Evolution* 10: 58-62.
- New Zealand Freshwater Fish Database. Available at <https://nzffdms.niwa.co.nz/search> (accessed 6 June 2017).
- No.8 Ltd 2017: McCulloughs Creek Hydropower Project, Whataroa, Westland, New Zealand. Environmental Impact Assessment in support of No.8 Limited - Department of Conservation Concession Application. 7 September 2017.
- Robertson H.A, Baird K., Dowding J.E., Elliott G.P., Hitchmough R.A., Miskelly C.M., McArthur N., O'Donnell C.F.J., Sagar P.M., Scofield R.P., and Taylor G.A. 2017: Conservation status of New Zealand birds, 2016. *New Zealand Threat Classification Series 19*. Wellington, Department of Conservation. 27 pp.
- Townsend A.J., de Lange P.J., Duffy C.A.J., Miskelly C.M., Molloy J. and Norton D.A. 2008: *New Zealand Threat Classification System Manual*. Department of Conservation, Wellington. 36 pp.
- Wassilieff M.C. and Timmins S. (compilers) 1984: Register of Protected Natural Areas in New Zealand. Department of Lands and Survey, Wellington. 468 pp.

## PLANT SPECIES LIST FOR MCCULLOUGH'S CREEK HYDROPOWER PROJECT AREA

Indigenous plant species recorded in the project area on 16 May 2017.

### Vascular Plant Species

Scientific Name	Common Name	Life Form
<i>Acaena anserinifolia</i>	Bidibidi, piri-piri	Dicot herb
<i>Anaphalioides trinervis</i>		Dicot herb
<i>Aristolelia serrata</i>	Wineberry, makomako	Tree
<i>Ascarina lucida</i>	Hutu	Dicot herb
<i>Asplenium bulbiferum</i>	Hen & chicken's fern	Fern
<i>Asplenium flaccidum</i>	Hanging spleenwort, raukatauri	Fern
<i>Asplenium polyodon</i>	Sickle spleenwort	Fern
<i>Astelia fragrans</i>	Kakaha, bush lily	Monocot herb
<i>Blechnum chambersii</i>	Lance fern	Fern
<i>Blechnum colensoi</i>	Colenso's hard fern, peretao	Fern
<i>Blechnum discolor</i>	Crown fern, piupiu	Fern
<i>Blechnum fluviatile</i>	Kiwakiwa	Fern
<i>Blechnum nigrum</i>	Black hard fern	Fern
<i>Blechnum novae-zelandiae</i>	Kiokio	Fern
<i>Carex</i> species	Cutty grass	Sedge
<i>Carmichaelia arborea</i>	South Island broom, tree broom, swamp broom	Shrub
<i>Carpodetus serratus</i>	Marbleleaf, putaputawētā	Tree
<i>Chionochoa conspicua</i>	Broad-leaved bush tussock, hunangamoho	Grass
<i>Coprosma depressa</i>		Shrub
<i>Coprosma dumosa</i>	Mikimiki	Shrub
<i>Coprosma foetidissima</i>	Stinkwood, hupiro	Tree
<i>Coprosma grandifolia</i>	Kanono	Tree
<i>Coprosma lucida</i>	Karamū	Tree
<i>Coprosma propinqua</i>	Mikimiki, mingimingi	Shrub
<i>Coprosma rotundifolia</i>	Round-leaved coprosma, mikimiki	Shrub
<i>Coriaria arborea</i>	Tree tutu	Shrub
<i>Cyathea smithii</i>	Smith's tree fern, kātote	Fern
<i>Dacrydium cupressinum</i>	Rimu	Tree
<i>Dacrycarpus dacrydioides</i>	Kahikatea	Tree
<i>Dicksonia squarrosa</i>	Whēkī, rough tree fern	Fern
<i>Earina autumnalis</i>	Easter orchid, raupeka	Orchid
<i>Epilobium glabellum</i>	Willowherb	Dicot herb
<i>Epilobium</i> species	Willowherb	Dicot herb
<i>Freycinetia banksii</i>	Kiekie	Vine
<i>Fuchsia excorticata</i>	Tree fuchsia, kōtukutuku	Tree
<i>Gingidia montana</i>	Mountain aniseed	Dicot herb
<i>Griselinia littoralis</i>	Broadleaf, kāpuka	Tree
<i>Gunnera prorepens</i>	Native gunnera	Dicot herb
<i>Hebe salicifolia</i>	Koromiko	Shrub
<i>Hedycarya arborea</i>	Pigeonwood, porokaiwhiri	Tree
<i>Histiopteris incisa</i>	Water fern, mātātā	Fern
<i>Hoheria glabrata</i>	Lacebark, houhere	Tree
<i>Hydrocotyle novae-zeelandiae</i>	Pennywort	Dicot herb
<i>Hymenophyllum demissum</i>	Filmy fern	Fern
<i>Hymenophyllum ferrugineum</i>	Rusty filmy fern	Fern
<i>Hymenophyllum multifidum</i>	Filmy fern	Fern
<i>Hymenophyllum revolutum</i>	Filmy fern	Fern
<i>Hymenophyllum scabrum</i>	Filmy fern	Fern
<i>Hymenophyllum</i> species	Filmy fern	Fern



Scientific Name	Common Name	Life Form
<i>Hypolepis</i> species		Fern
<i>Jovellana repens</i>		Dicot herb
<i>Lastreopsis glabella</i>	Smooth shield fern	Fern
<i>Lastreopsis hispida</i>	Hairy shield fern	Fern
<i>Leptinella squalida</i>	Button daisy	Dicot herb
<i>Leptopteris superba</i>	Prince of Wales feathers, heruheru	Fern
<i>Lobelia angulata</i>	Pratia	Dicot herb
<i>Luzula</i> species	Woodrush	Sedge
<i>Melicytus ramiflorus</i>	Māhoe, whiteywood	Tree
<i>Metrosideros diffusa</i>	White climbing rātā	Vine
<i>Metrosideros perforatā</i>	White rātā	Vine
<i>Metrosideros umbellata</i>	Southern rātā	Tree
<i>Microlaena avenacea</i>	Bush rice grass	Grass
<i>Microsorium pustulatum</i>	Hounds tongue, kōwaowao	Fern
<i>Muehlenbeckia australis</i>	Large-leaved pōhuehue	Vine
<i>Myrsine australis</i>	Red māpou, red matipo	Tree
<i>Nertera depressa</i>	Nertera	Dicot herb
<i>Nertera villosa</i>	Nertera	Dicot herb
<i>Notogrammitis billardiarei</i>	Common strap fern	Fern
<i>Notogrammitis heterophylla</i>	Comb fern	Fern
<i>Olearia arborescens</i>	Common tree daisy, glossy tree daisy	Tree
<i>Olearia avicenniifolia</i>	Mountain akeake	Tree
<i>Olearia ilicifolia</i>	NZ holly, hakeke	Tree
<i>Pennantia corymbosa</i>	Kaikōmako, ducks foot	Tree
<i>Phlegmariurus varius</i>	Clubmoss	Fern
<i>Phormium cookianum</i>	Mountain flax, wharariki	Monocot herb
<i>Pittosporum colensoi</i>		Tree
<i>Polystichum vestitum</i>	Prickly shield fern, pūniu	Fern
<i>Prumnopitys ferruginea</i>	Miro	Tree
<i>Pseudopanax colensoi</i>	Mountain five-finger	Tree
<i>Pseudowintera coloratā</i>	Horopito, peppertree	Tree
<i>Pyrrosia eleagnifolia</i>	Leatherleaf fern	Fern
<i>Quintinia serrata</i>	Quintinia, tāwheowheo	Tree
<i>Raoulia tenuicaulis</i>	Scabweed	Dicot herb
<i>Raukaua simplex</i>	Three-finger	Tree
<i>Ripogonum scandens</i>	Supplejack, kareao	Vine
<i>Rubus cissoides</i>	Bush lawyer, tātarāmoa	Vine
<i>Rumohra adiantiformis</i>	Leathery shield fern	Fern
<i>Schefflera digitata</i>	Patē, seven-finger	Tree
<i>Trichomanes venosum</i>	Veined filmy fern	Fern
<i>Uncinia uncinata</i>	Hook grass	Sedge
<i>Weinmannia racemosa</i>	Kāmahi	Tree

## **Non-Vascular Plant Species**

Scientific Name	Life Form
<i>Cyathophorum bulbosum</i>	Moss
<i>Lembophyllum</i> species	Moss
<i>Marchantia</i> species	Liverwort
<i>Peltigera</i> species (c.f. <i>dolichorhiza</i> )	Lichen
<i>Placopsis</i> species	Lichen
<i>Pseudocyphellaria cinnamomea</i>	Lichen
<i>Pseudocyphellaria rufovirescens</i>	Lichen
<i>Stereocaulon ramulosum</i>	Lichen
<i>Sticta filix</i>	Lichen
<i>Usnea</i> species	Lichen

## KEY FRESHWATER FISH SPAWNING AND MIGRATION TIMES

The table below lists critical spawning and migration times for all freshwater fish species found in McCulloughs Creek during the May 2017 survey and for selected species from the Whataroa catchment as recorded in the New Zealand Freshwater Fish Database (June 2017). Some species recorded in the Whataroa Catchment (inanga, brown mudfish, giant kōkopu, banded kōkopu and common bully) are not included in the table because they are unlikely to be present in McCulloughs Creek near the proposed works (McDowall 1990 and 2000).

The most important months to avoid in-stream works are in **bold type**. These are months when eggs and larvae are likely to be present in or near the substrate, and when very young juveniles are migrating (Charteris 2006; McDowall 1990 and 2000). These life stages are more vulnerable to destruction and less able to avoid danger in the way that adult fish can.

Common Name	Scientific Name	Spawning Times	Migration Direction	
			Upstream	Downstream
Longfin eel/tuna	<i>Anguilla dieffenbachi</i>	Autumn to winter	<b>July to November</b>	February to June
Shortfin eel/tuna	<i>Anguilla australis</i>	Autumn to winter	<b>July to November</b>	February to June
Kōaro	<i>Galaxias brevipinnis</i>	Autumn to winter	<b>August to October</b>	March to June
Torrentfish	<i>Cheimarrichthys fosteri</i>	Summer to autumn	<b>June to November</b>	February to May
Brown trout	<i>Salmo trutta</i>	Autumn to winter	<b>June to October</b>	n/a



# Wildlands

*Providing outstanding ecological services  
to sustain and improve our environments*

Call Free 0508 WILDNZ  
Ph: +64 7 343 9017  
Fax: +64 7 3439018  
ecology@wildlands.co.nz

99 Sala Street  
PO Box 7137, Te Ngae  
Rotorua 3042,  
New Zealand

Regional Offices located in  
Auckland, Hamilton, Tauranga,  
Whakatane, Wellington,  
Christchurch and Dunedin

**ECOLOGY RESTORATION BIODIVERSITY SUSTAINABILITY**

[www.wildlands.co.nz](http://www.wildlands.co.nz)

